

# Normal & Pathological Gait

Dr. Ziad Hawamdeh

# Gait Cycle - Definitions:

Normal  
Gait =

- Series of rhythmical , alternating movements of the trunk & limbs which result in the forward progression of the center of gravity
- series of 'controlled falls'

# Task involves in walking

According  
to “Rancho  
Los  
Amigos”  
(RLA),  
California

- Weight acceptance
- Single limb support
- Swing limb advance

# Gait Cycle - Components:

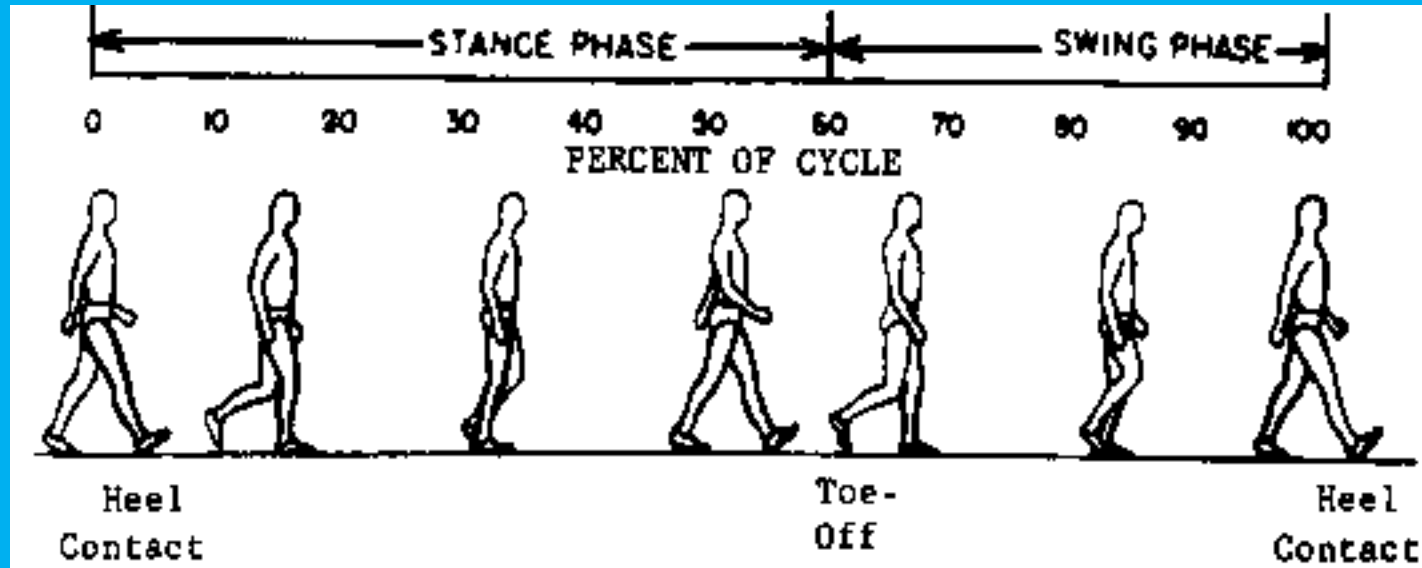

## Phases:

- **Stance Phase:**
  - reference limb
  - in contact
  - with the floor

- (2) **Swing Phase:**
  - reference limb
  - not in contact
  - with the floor

# Gait Cycle - Components:

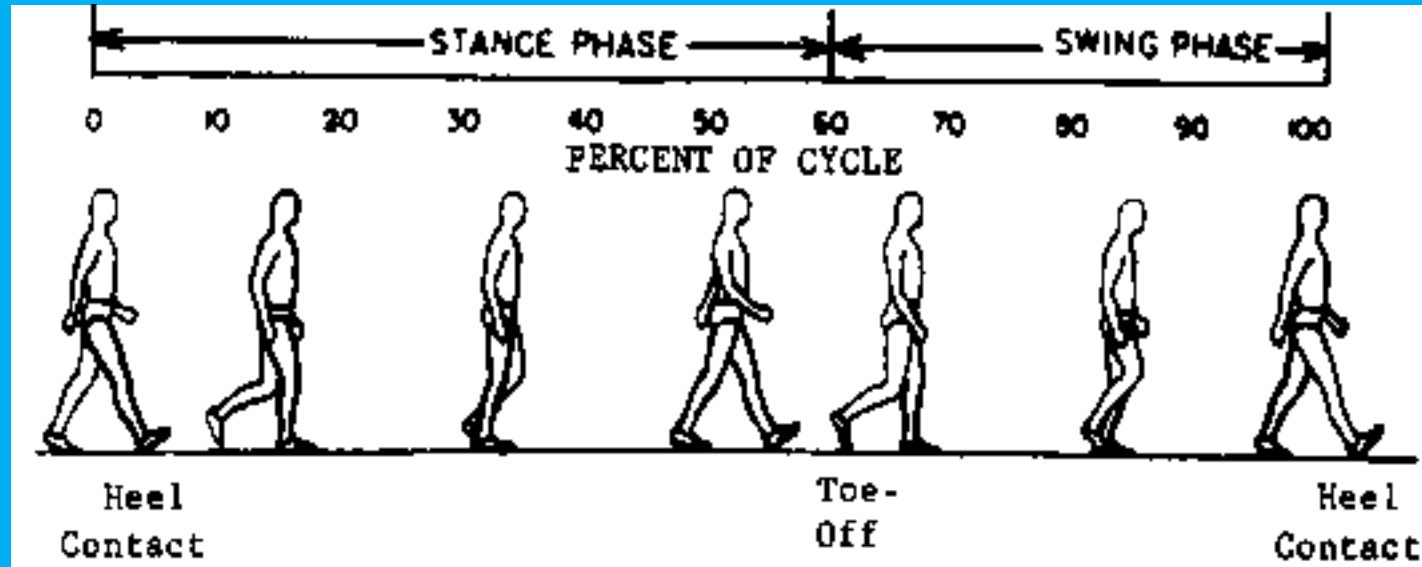

## Support:

- Single Support: only one foot in contact with the floor
- Double Support: both feet in contact with floor

# Kinematics of gait

Phases of gait:

Stance phase

Swing phase

# Stance phase

It begins at the instant that one extremity contacts the ground & continuous only as long as some portion of the foot is in contact with the ground.

It is approx 60% of normal gait duration.



# Swing phase

It begins as soon as the toe of one extremity leaves the ground & ceases just before heel strike or contact of the same extremity.

It makes up 40% of normal gait cycle.

# Double support

Lower limb of one side of body is beginning its stance phase & the opposite side is ending its stance phase.

During double support both the lower limb are in contact with the ground at the same time.

It account approx 22% of gait cycle.

This phase is absent in running

# variables

## Temporal variable

- Stance time
- Single-limb & double-support time,
- Swing time,
- Stride and step time,
- Cadence
- Speed

## Distance variable

- Stride length
- Step length and width
- Degree of toe-out

# Stride length:

- It is the linear distance from the heel strike of one lower limb to the next heel strike of the same limb.

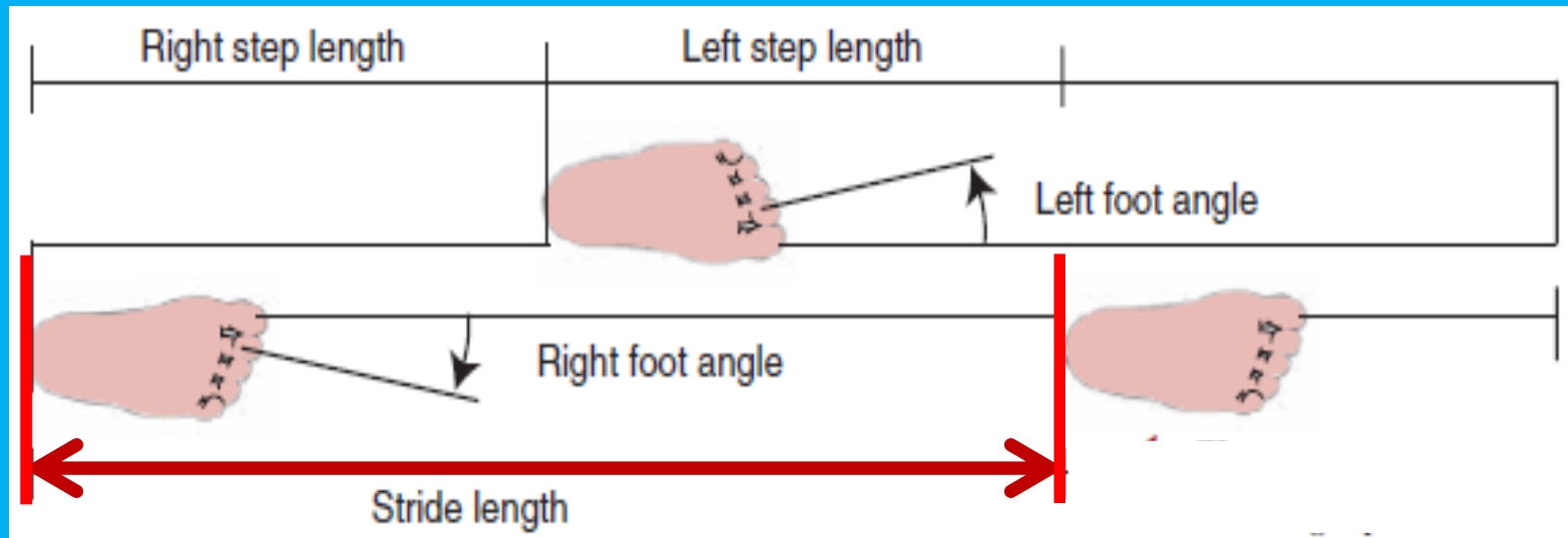

# Step length:

It is the linear distance from the heel strike of one lower limb to the next heel strike of opposite limb.

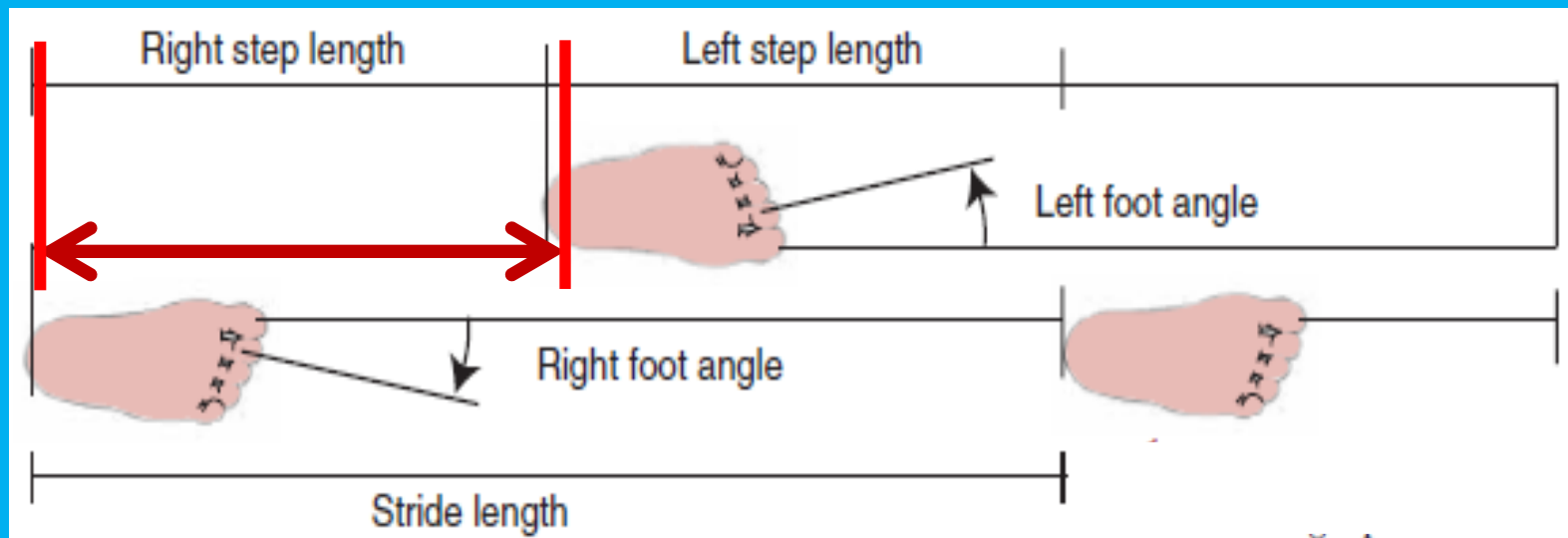

# Stride duration:

- It refers to amount of time taken to accomplish one stride.
- Stride duration and gait cycle duration are synonymous.
- One stride, for a normal adult, lasts approx 1 sec

## Step duration:

It refers to the amount of time spent during a single step.

Measurement usually is expressed as sec/step.

When weakness or pain in limb, step duration may be decreased on the affected side and increased on the unaffected side.

## Cadence:

It is the no of steps taken by a person per unit of time.

It is measured as the no of steps / sec or per minute.

$$\text{Cadence} = \text{Number of steps} / \text{Time}$$



# Walking velocity:

It is the rate of linear forward motion of the body, which can be measured in meters or cm/second, meters/minute, or miles/hour.

Walking velocity (meters/sec) = Distance walked (meters) / time (sec)

# Speed of gait:

It is referred to as slow, free, and fast.

Free speed of gait refers to a person's normal walking speed

Slow & fast speeds of gait refer to speeds slower or faster than the person's normal comfortable walking speed, designated in a variety of ways.

# Step width or width of the walking base

It is the measure of linear distance between the midpoint of the heel of one foot and the same point on the other foot

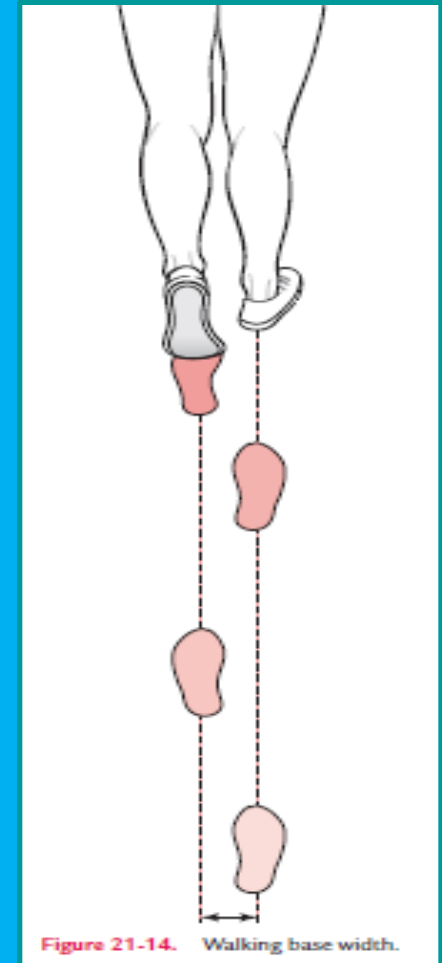

## Degree of toe-out (DTO):

It represents the angle of foot formed by each foot's line of progression and a line intersecting the centre of the heel and the second toe.

The angle for men is about  $7^{\circ}$  from the line of progression of each foot at free speed walking.

The DTO decreases as the speed of walking increases in normal men.

# Degree of toe out

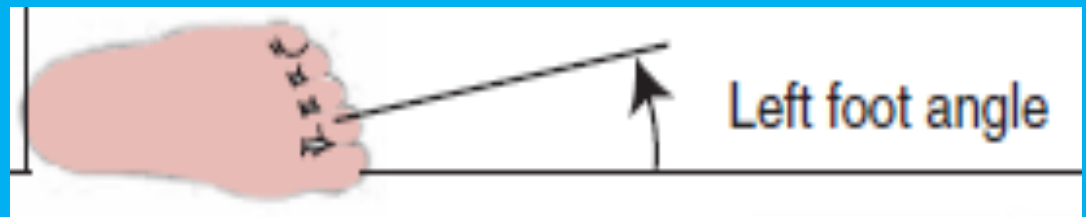

# Variables of gait

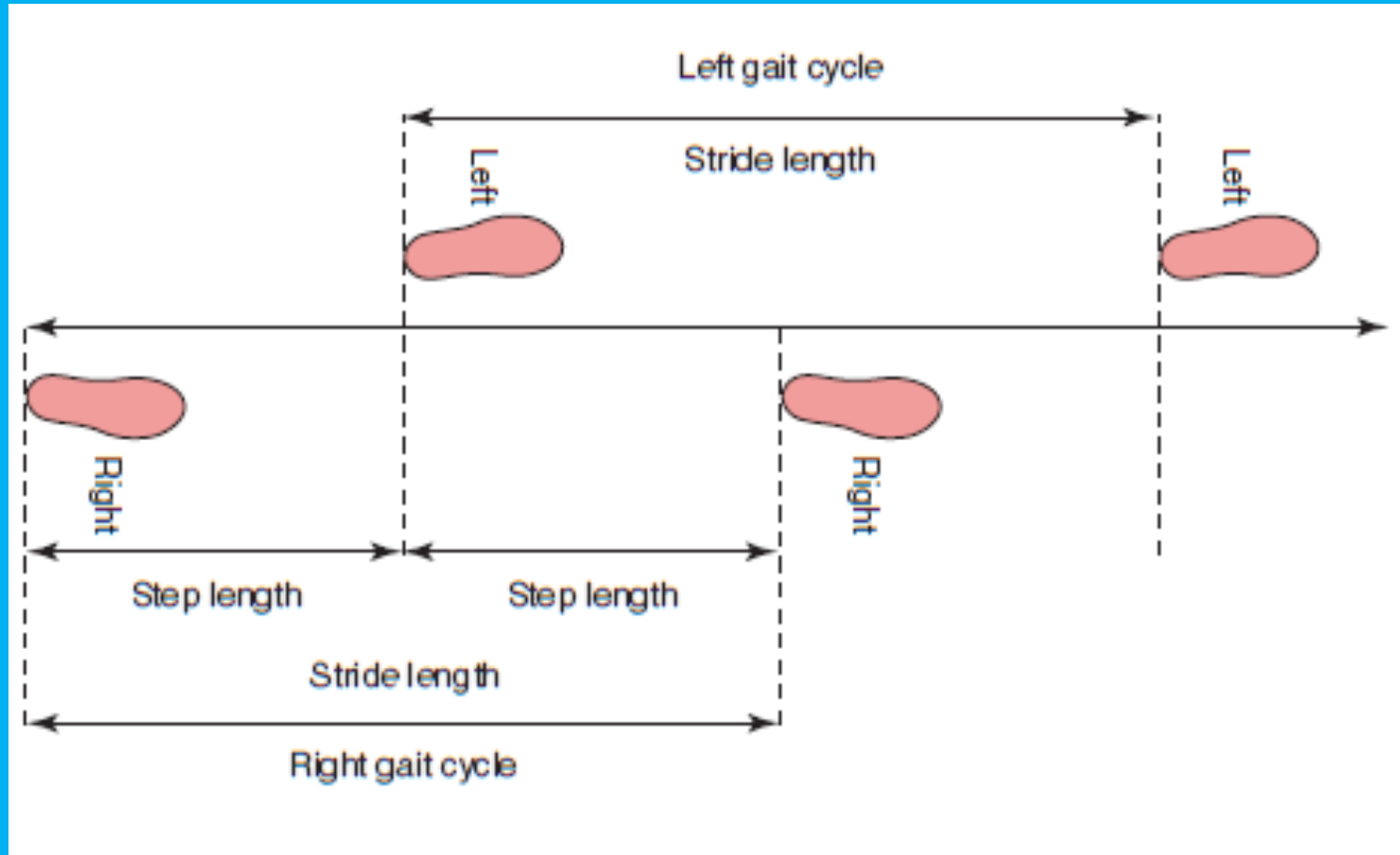

# Path of COG

Center of Gravity (CG):

- Midway between the hips
- Few cm in front of S2

Least energy consumption if CG travels in straight line

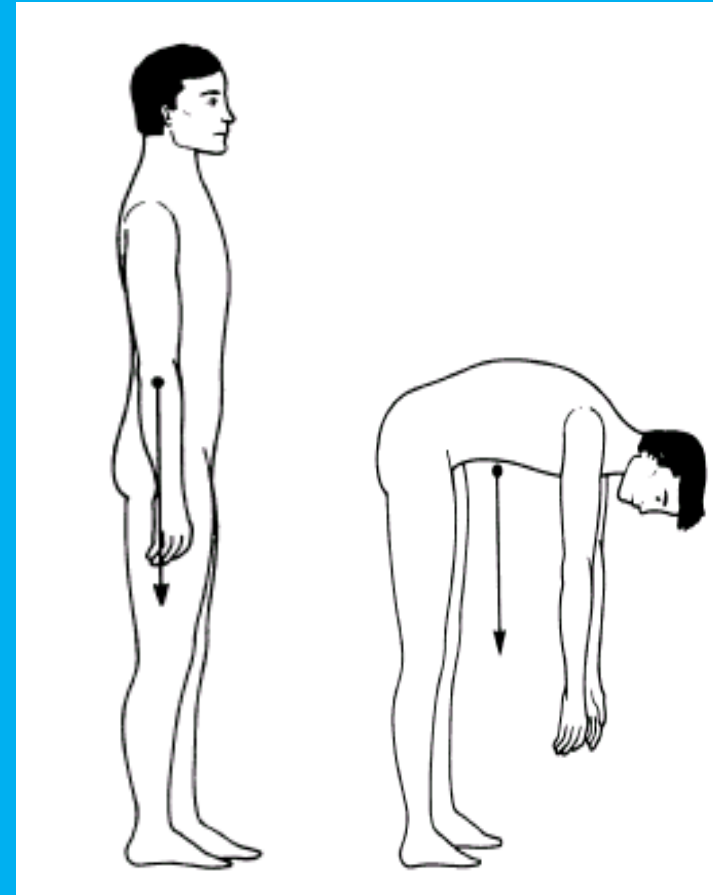

# Vertical displacement:

Rhythmic up & down movement

Highest point: midstance

Lowest point: double support

Average displacement: 5cm

Path: extremely smooth sinusoidal curve

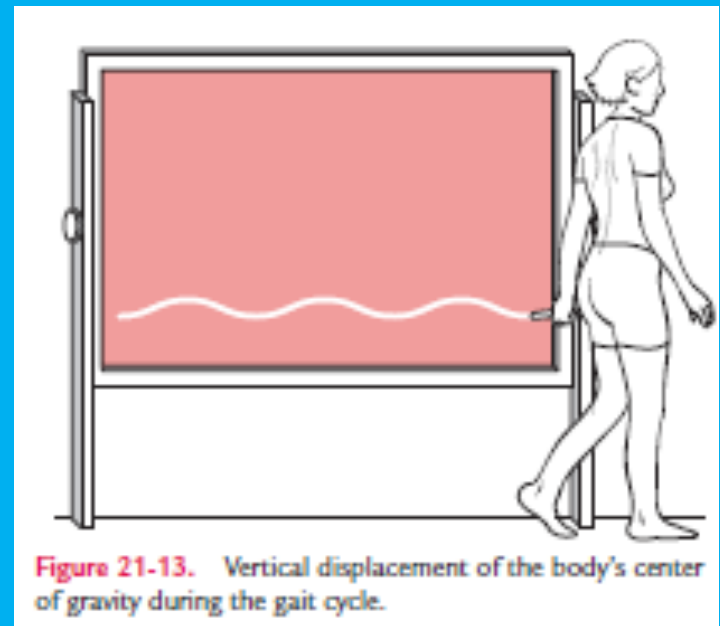



# Lateral displacement:

Rhythmic side-to-side movement

Lateral limit: mid-stance

Average displacement: 5cm

Path: extremely smooth sinusoidal curve

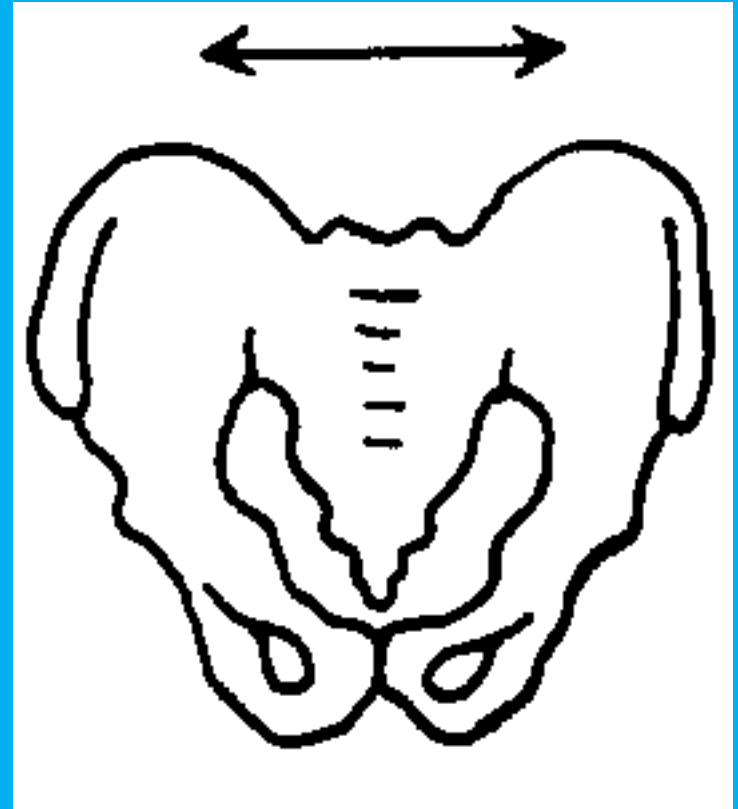

# Overall displacement:

Sum of vertical & horizontal displacement.

Movement of CG as seen from AP view.

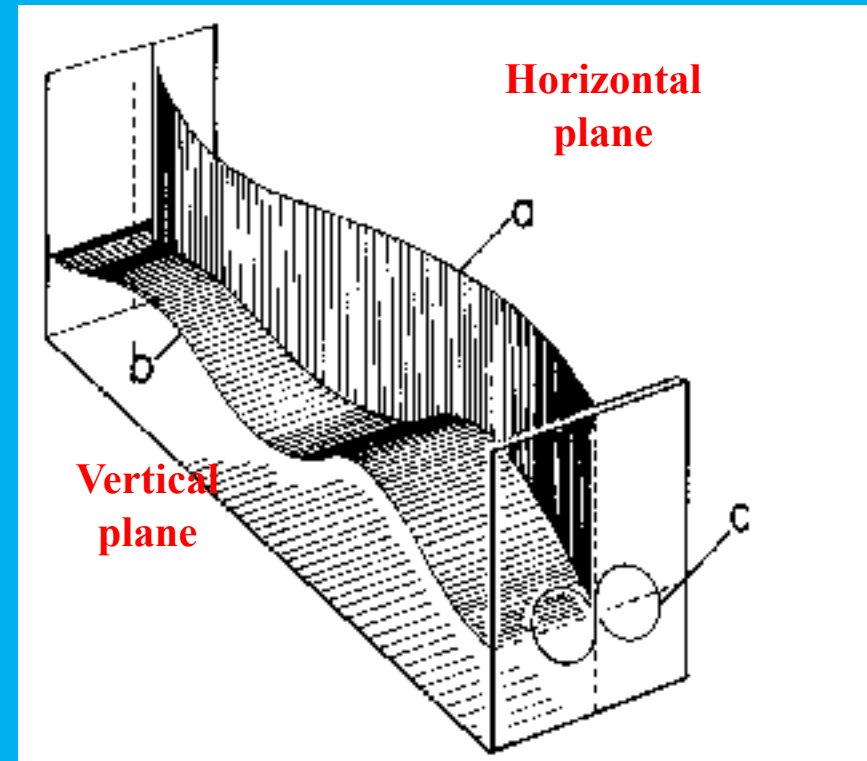

# Saunders' Determinants of gait

Six optimizations used to minimize excursion of CG in vertical & horizontal planes.

First described by "Saunders & Coworkers" in 1953.

# DETERMINANTS OF GAIT

## 1) Pelvic rotation:

Forward rotation of the pelvis in the horizontal plane approx. 8° on the swing-phase side

Reduces the angle of hip flexion & extension

Enables a slightly longer step-length w/o further lowering of CG

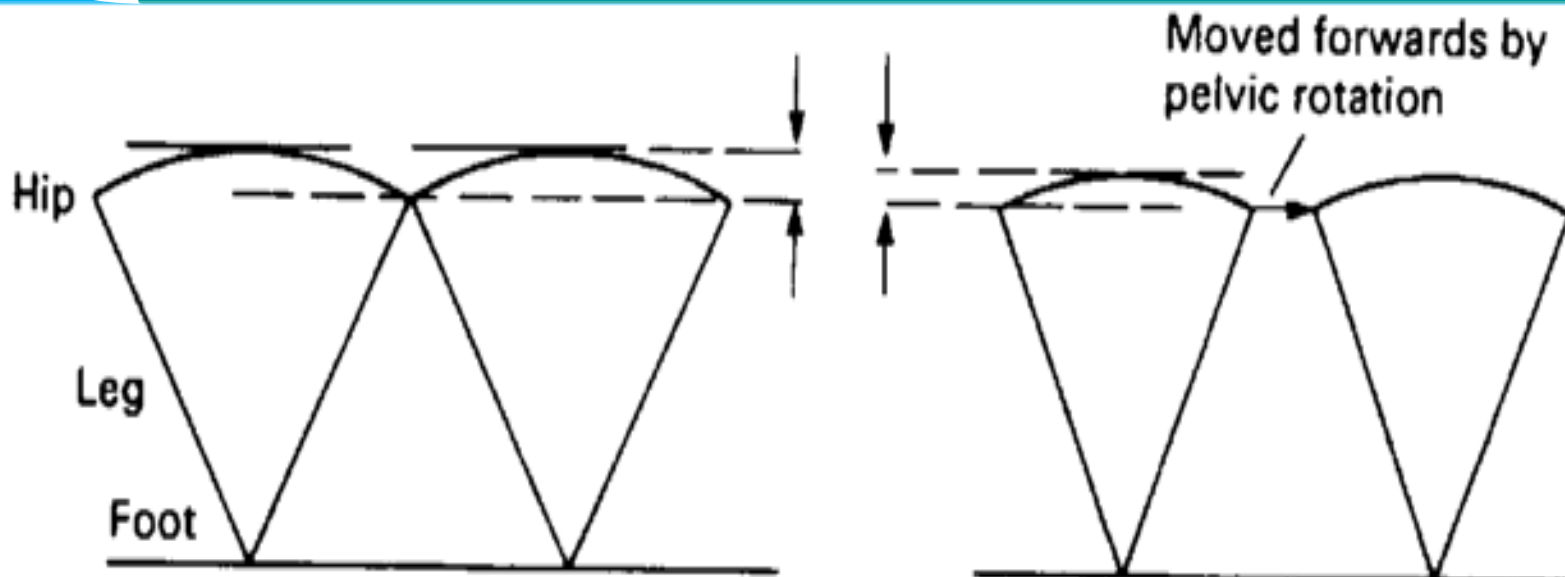

## (2) Pelvic tilt:

5 degree dip of the swinging side (i.e. hip adduction)

In standing, this dip is a positive Trendelenberg sign

Reduces the height of the apex of the curve of CG

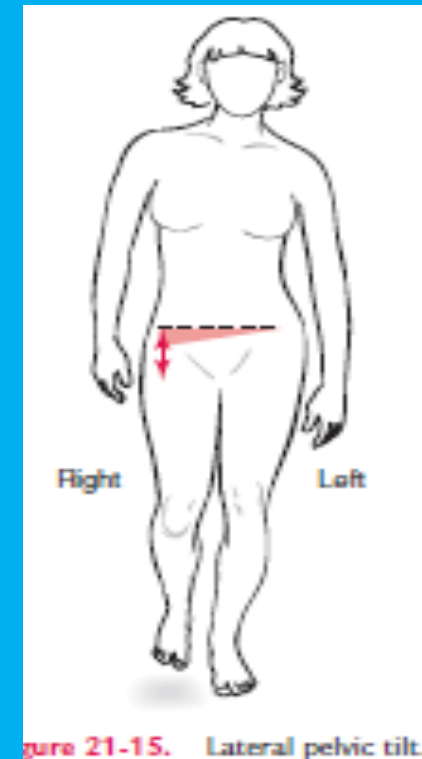
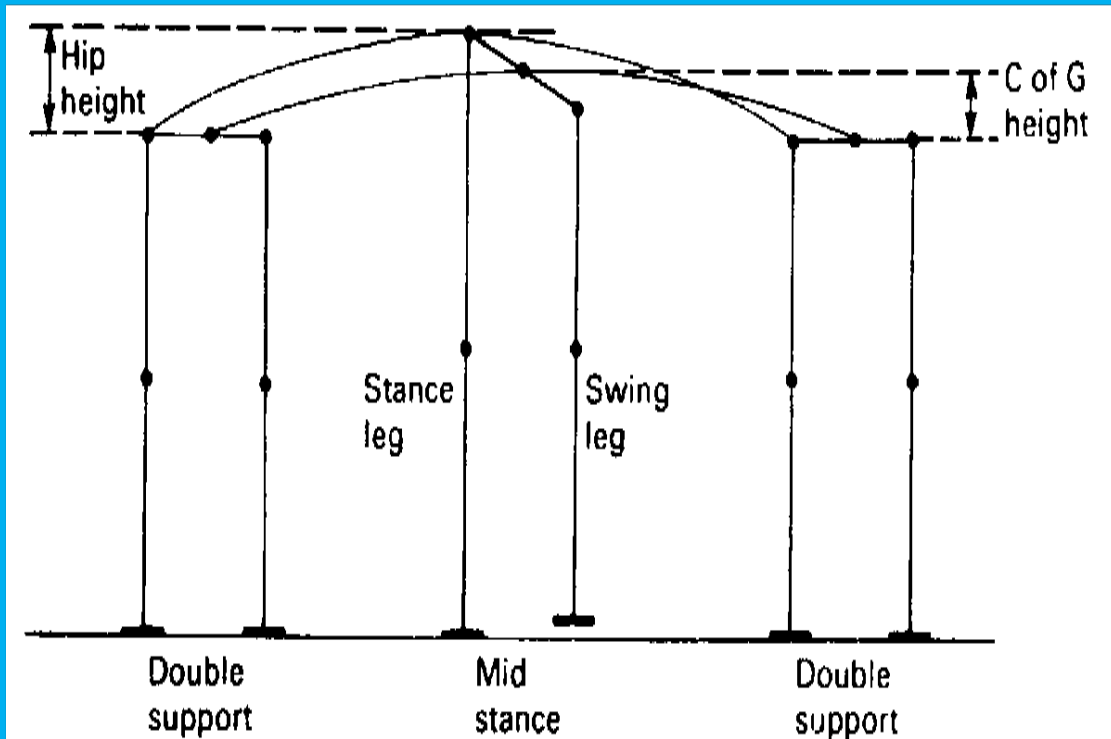

Figure 21-15. Lateral pelvic tilt.

### (3) Knee flexion in stance phase:

Approx. 20° dip

Shortens the leg in the middle of stance phase

Reduces the height of the apex of the curve of CG

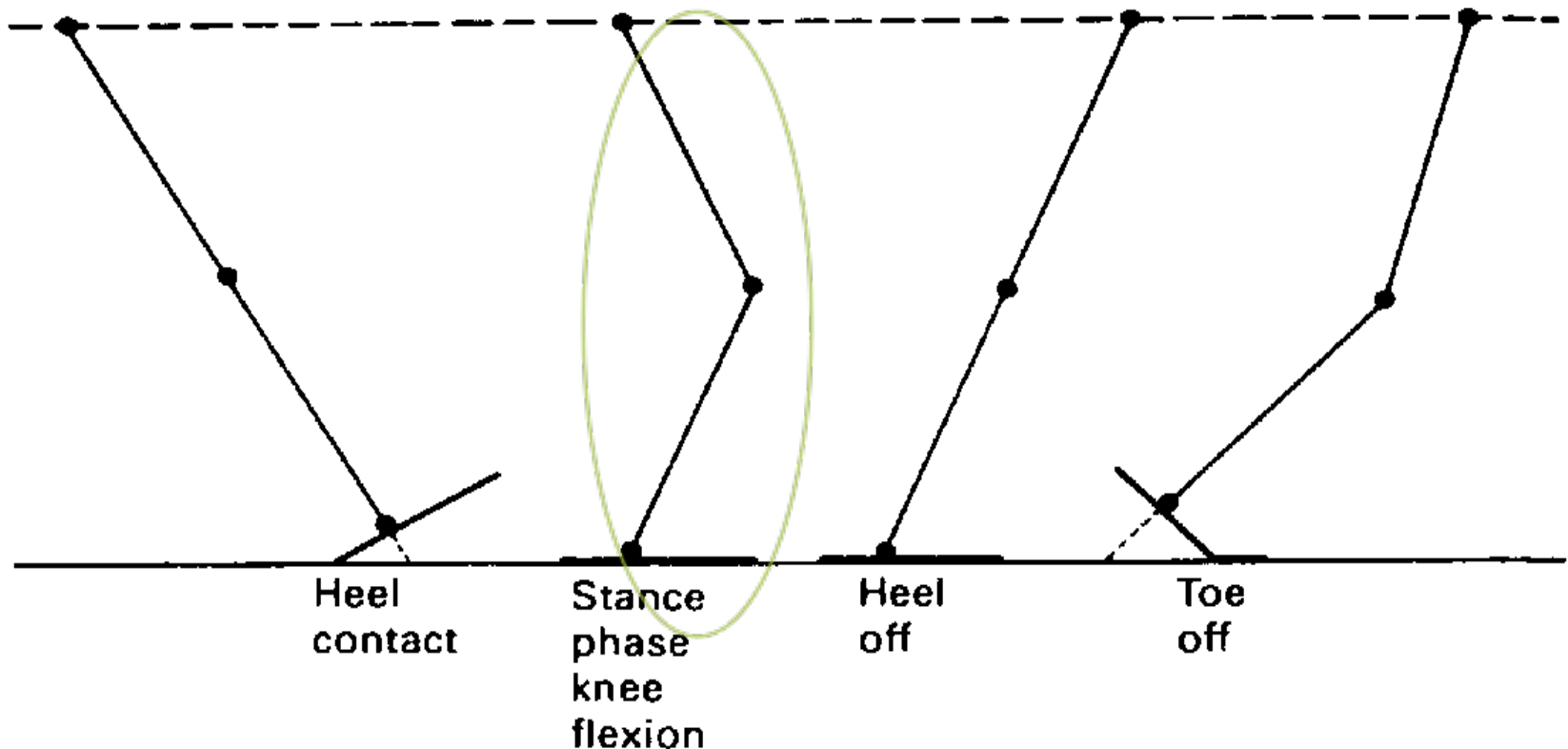

## (4) Ankle mechanism:

Lengthens the leg at heel contact

Smoothens the curve of CG

Reduces the lowering of CG

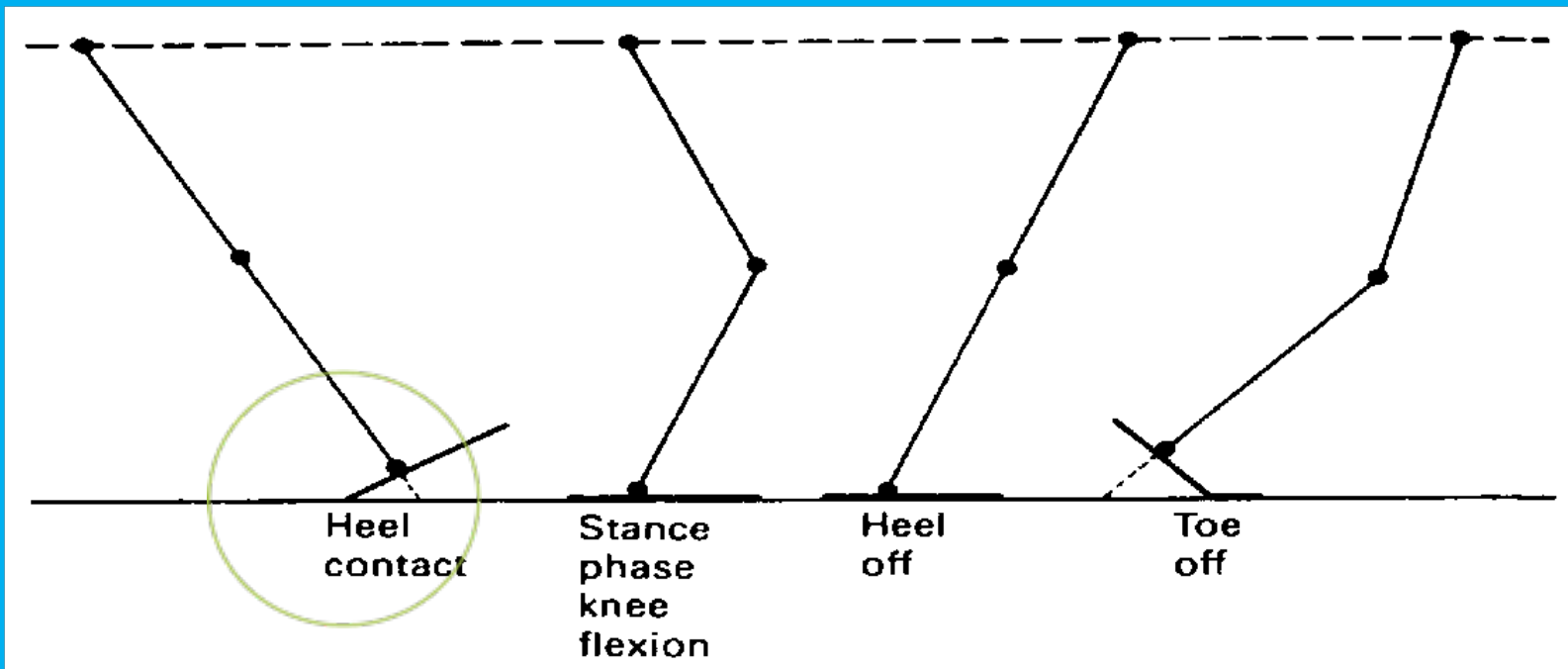

## (5) Foot mechanism:

Lengthens the leg at toe-off as ankle moves from dorsiflexion to plantarflexion

Smoothens the curve of CG

Reduces the lowering of CG

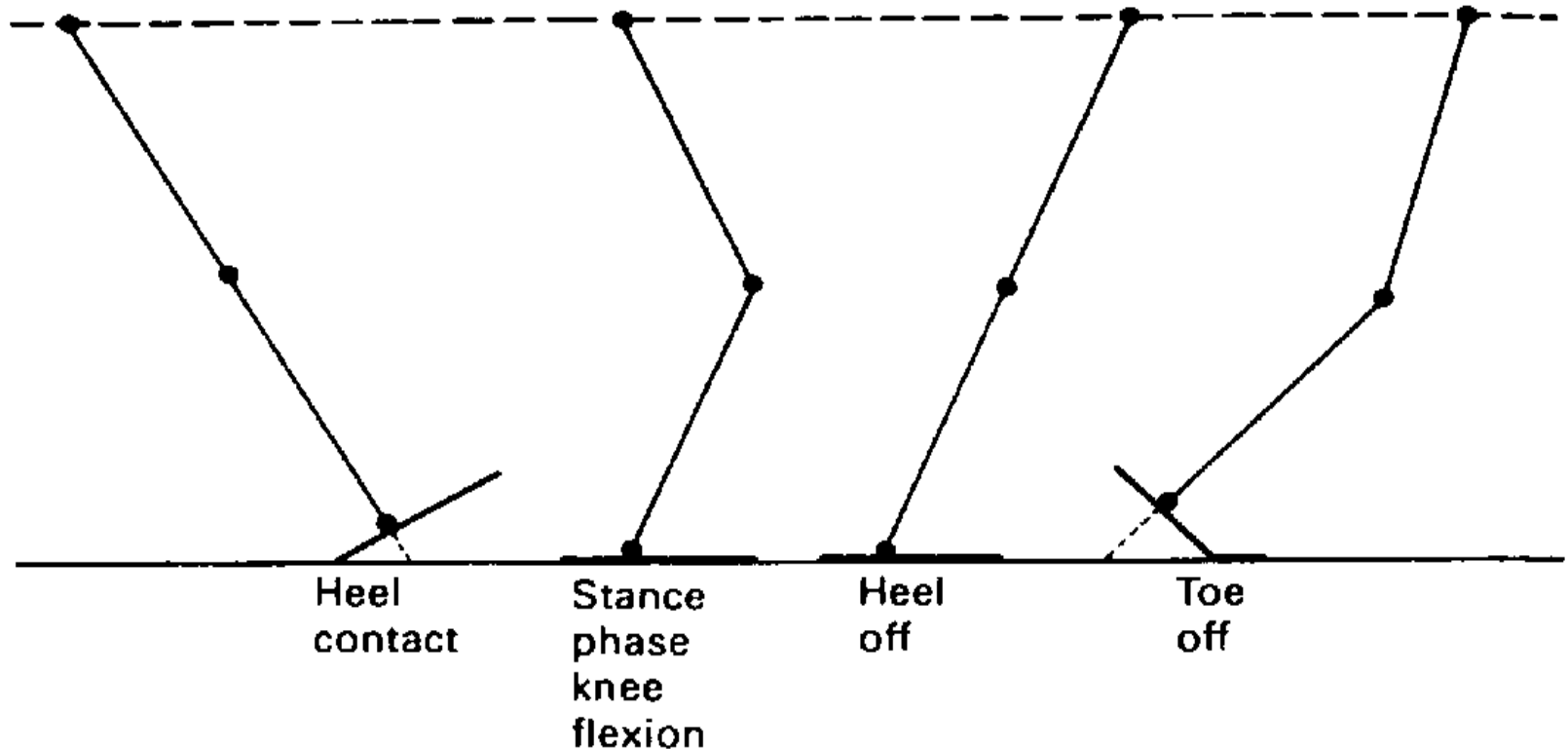



# Lateral displacement of body

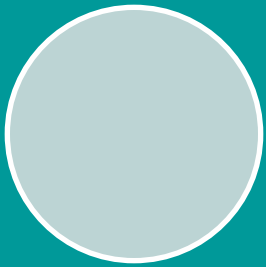

Physiologic valgus of the knee reduce side-to-side movement of the COM in frontal plane.

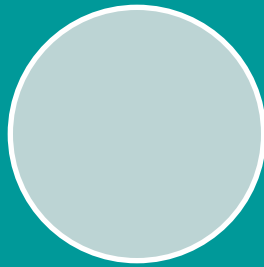

The normally narrow width of the walking base minimizes the lateral displacement of CG

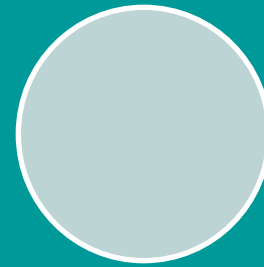

Reduced muscular energy consumption due to reduced lateral acceleration & deceleration



# Physiological valgus of knee

Reduces the base of support, so only little lateral motion of pelvis is necessary.

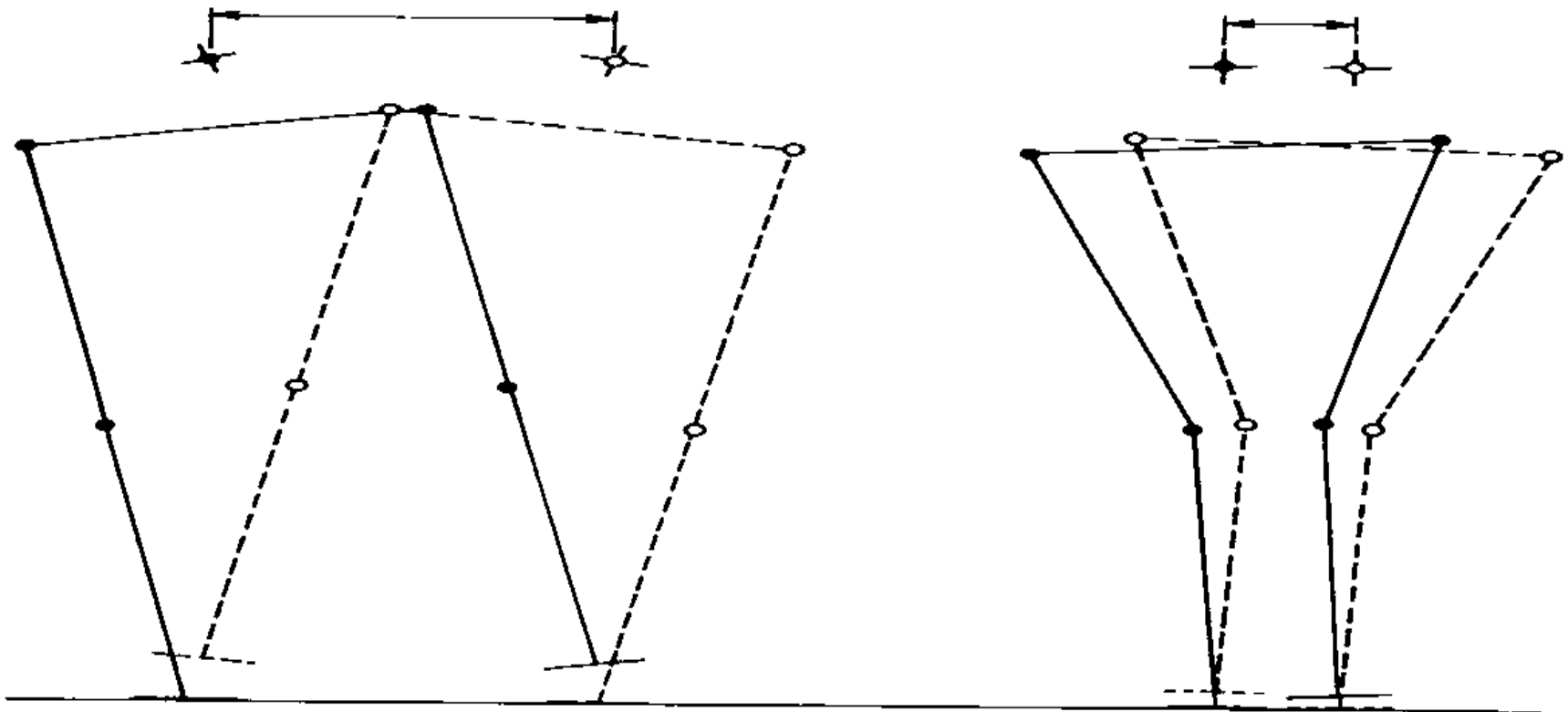

# Comparison of gait terminology

## Traditional

- Heel strike
- Foot flat
- Mid-stance
- Heel off
- Toe off
- Acceleration
- Mid-swing
- Deceleration

## RLA

- Initial contact
- Loading response
- Mid-stance
- Terminal stance
- Pre-swing
- Initial swing
- Mid-swing
- Terminal swing

# Sub component of stance phase

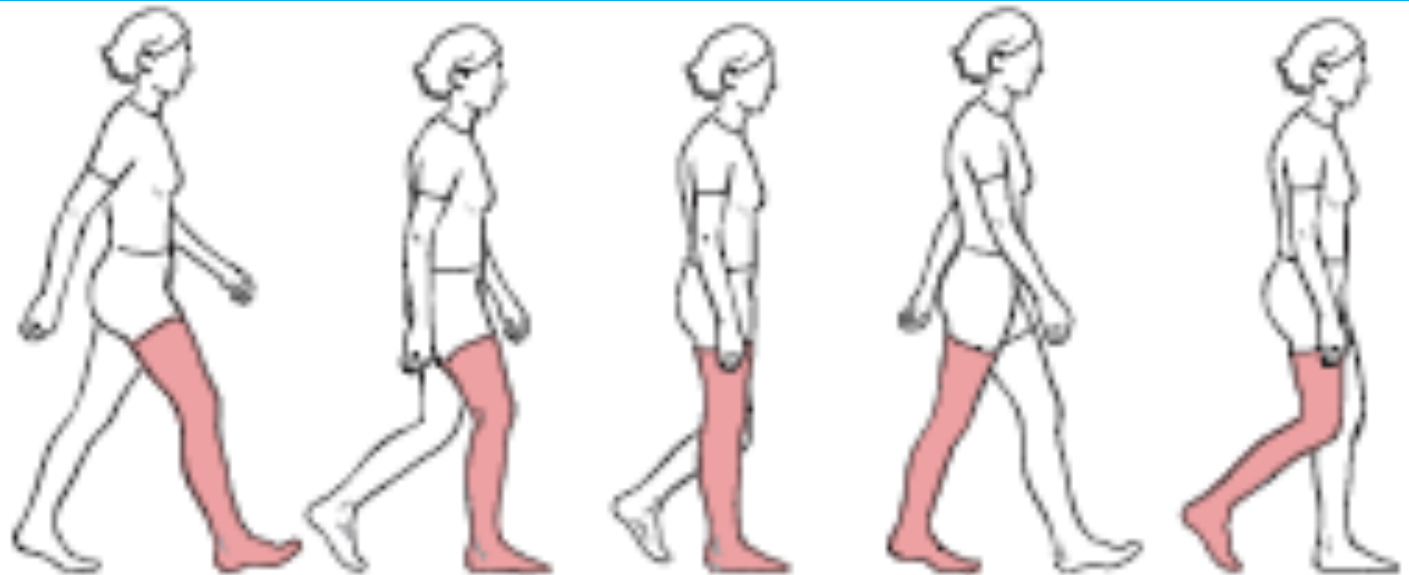

**Traditional terminology**

Heel strike

Foot flat

Midstance

Heel-off

Toe-off

**HLA terminology**

*Initial contact*

*Loading response*

*Midstance*

*Terminal stance*

*Pushing*

# Sub component of swing phase

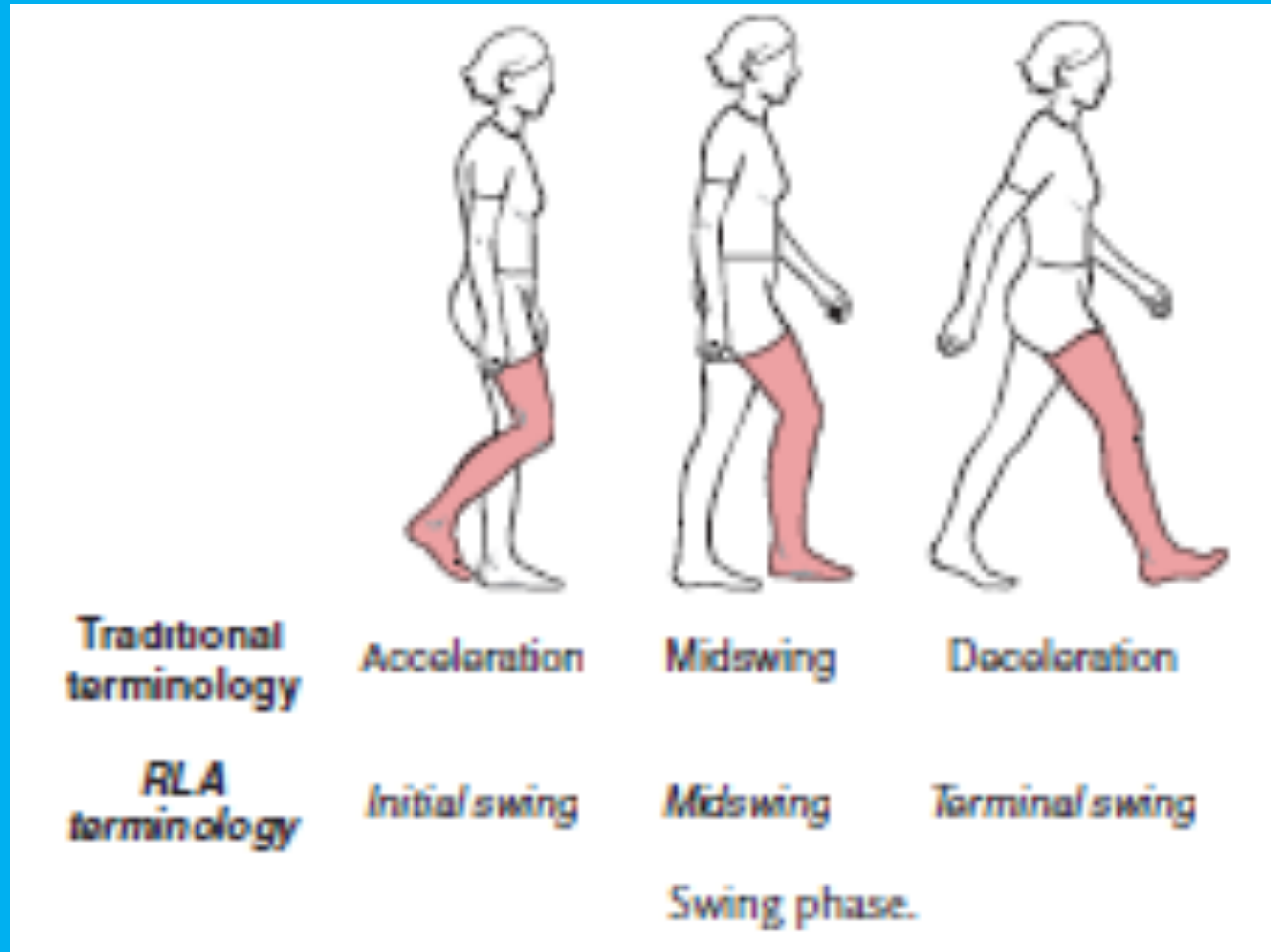

# RLA phases of gait

# Initial contact

It refer to the initial contact of the foot of leading lower limb.

Normally the heel pointed first to contact.

In abnormal gait it is possible to either whole foot or toes rather than the heel to strike.

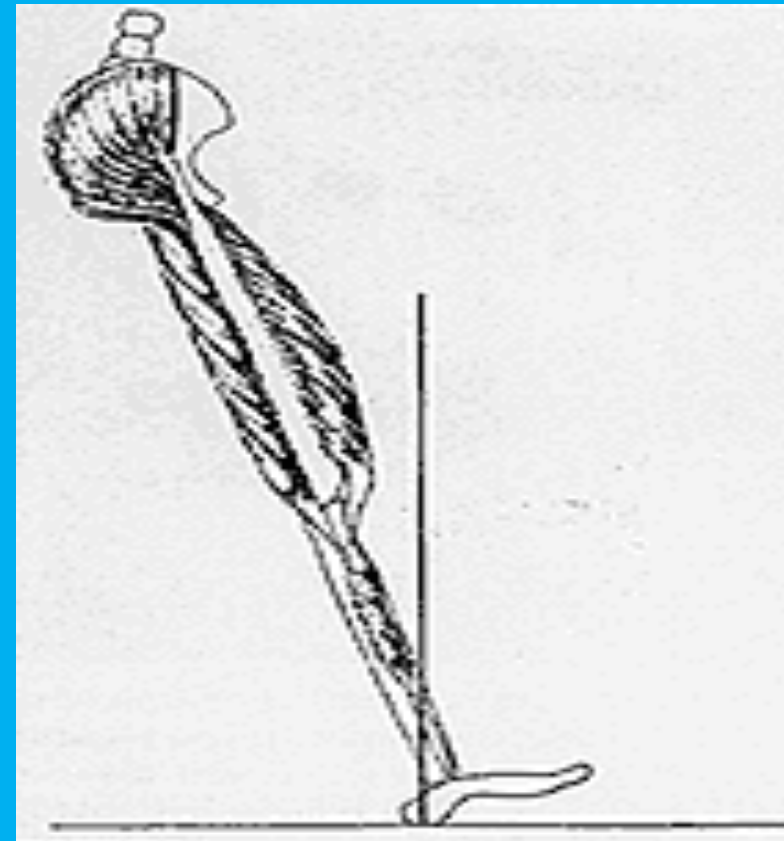

# Loading response

Begins at initial contact & ends when the contra lateral extremity lifts off the ground at the end of the double-support phase.

It occupies about 10% of gait

First rocker

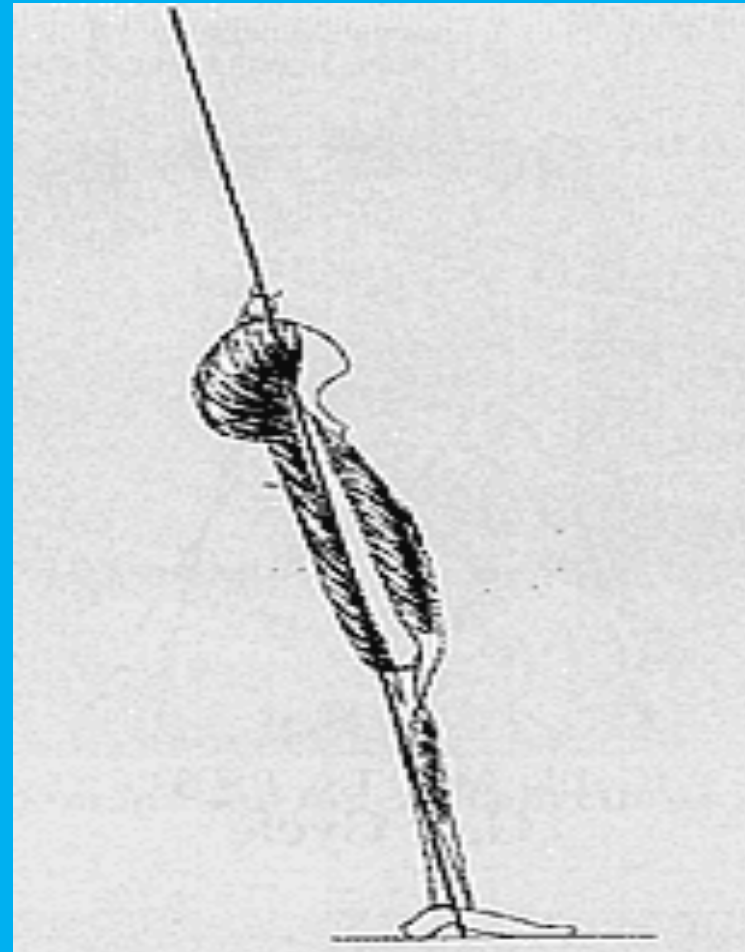



# Mid-stance phase (RLA)

Begins when the contra-lateral extremity lifts off the ground at about 11% of the gait cycle

Ends when the body is directly over the supporting limb at about 30% of the gait cycle.

2<sup>nd</sup> rocker

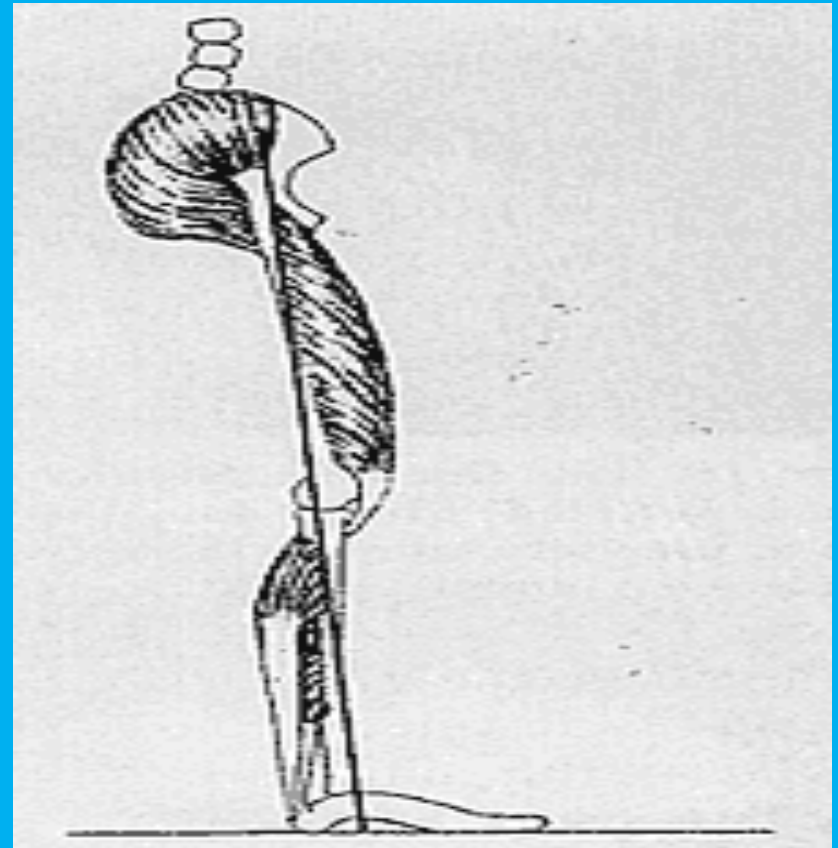

# Terminal stance (RLA)

Begins when the body is directly over the supporting limb at about 30% of the gait cycle

Ends just before initial contact of the contra-lateral extremity at about 50% of the gait cycle.

3<sup>rd</sup> rocker.

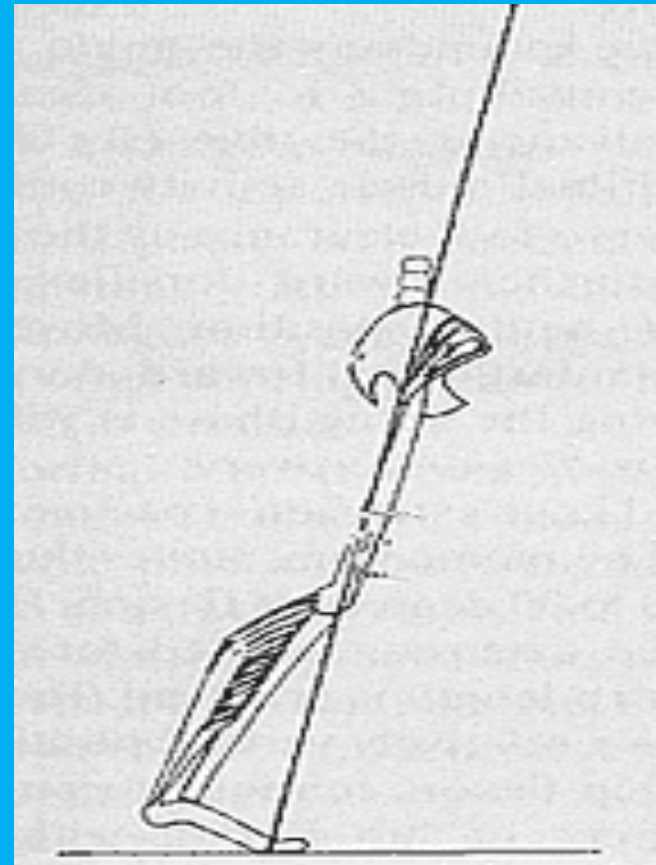

# Pre-Swing (RLA)

It is the last 10% of stance phase and begins with initial contact of the contra-lateral foot (at 50% of the gait cycle) and ends with toe-off (at 60%).

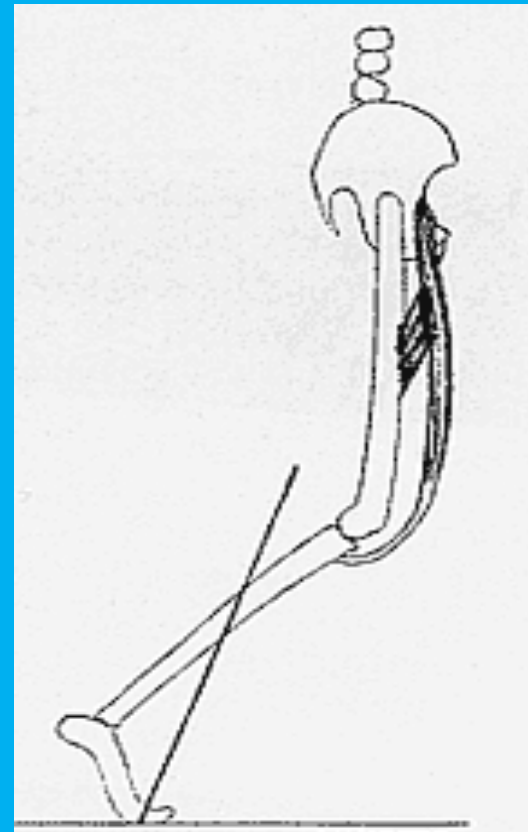

# Initial swing (RLA)

Begins when the toe leaves the ground & continues until max knee flexion occurs.

Ankle 20 deg. Plantar flexion ( max.)

Knee 60 deg. Flexion.

Hip 20 deg. Flexion.

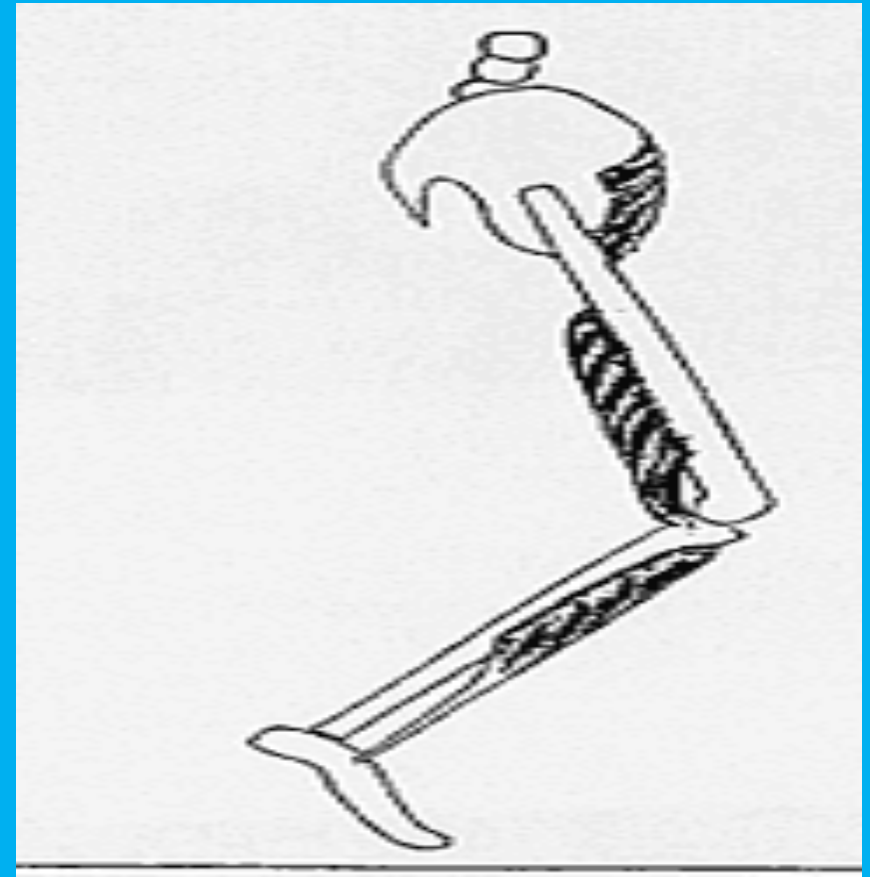

# Mid-Swing (RLA)

Encompasses the period from maximum knee flexion until the tibia is in a vertical position.

Ankle dorsiflexes.

Knee extends (60-30).

Hip flexed 30.

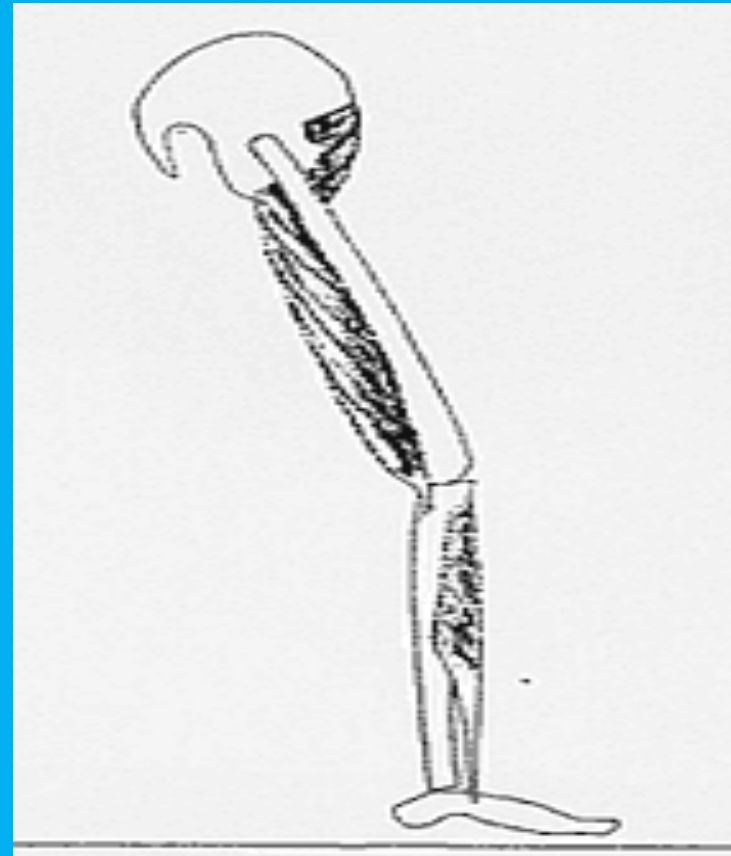

# Terminal swing (RLA)

Includes the period from the point at which the tibia is in the vertical position to a point just before initial contact.

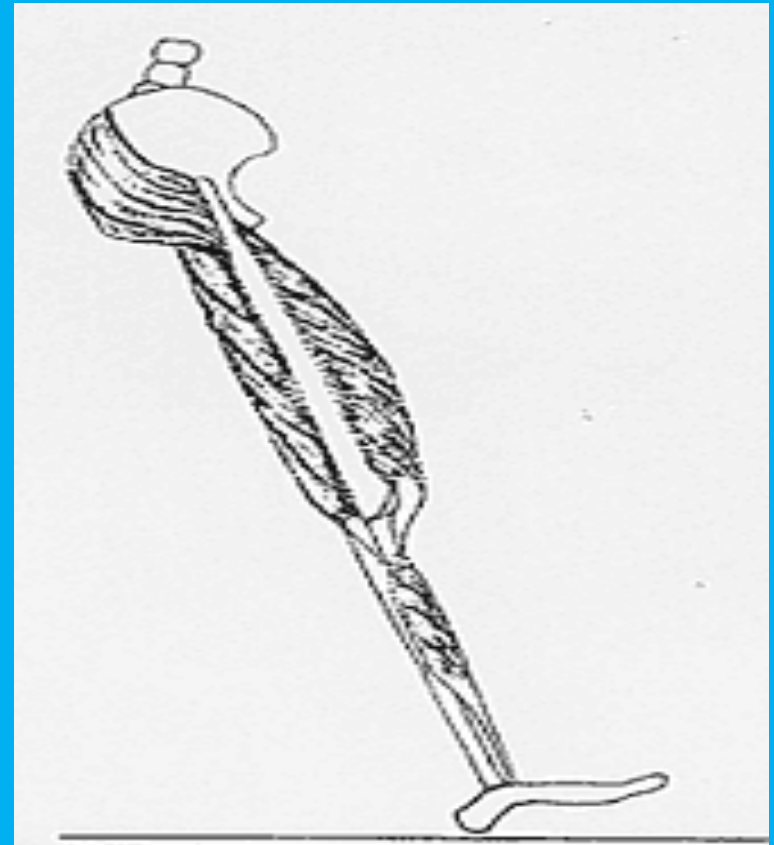

# Muscle activity

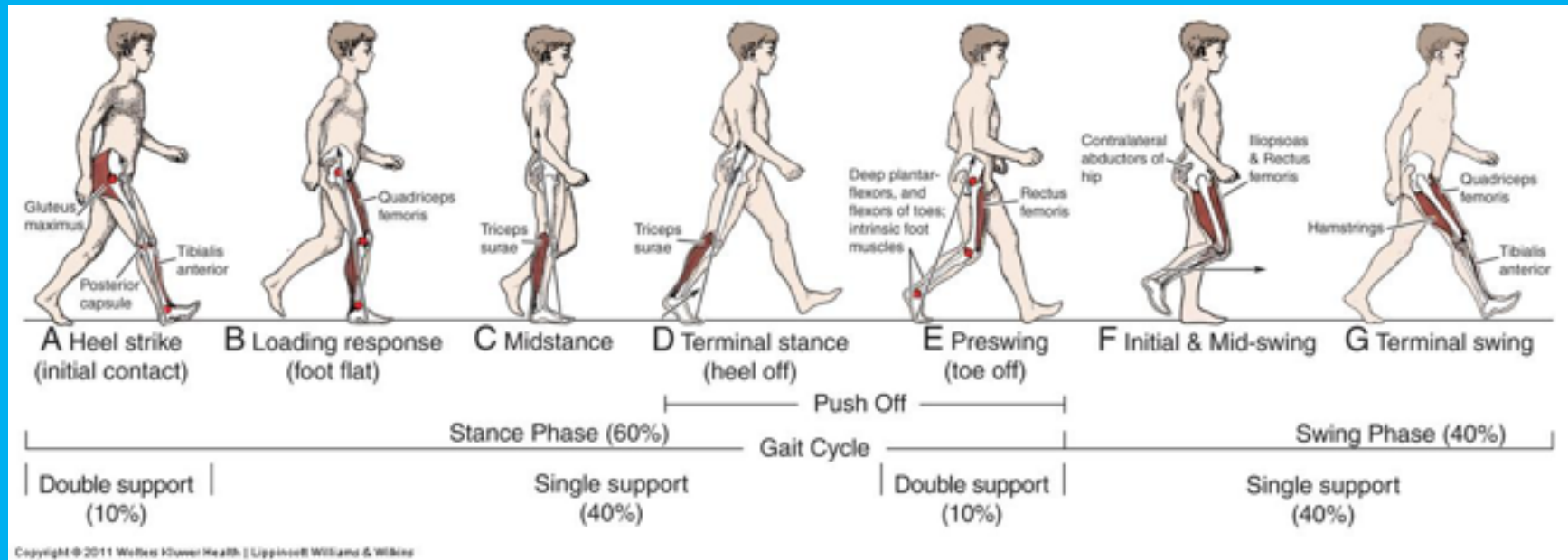

# Factors affecting variables



Age

Gender

Height

Size & shape of bony components

Distribution of mass in body segments



Joint mobility

Muscle strength

Type of clothing & footwear

Habit

Psychological status.



# Abnormal (Atypical) Gait

# Causes of abnormal gait

Pain

Joint muscle range-of-motion (ROM) limitation

Muscular weakness/paralysis

Neurological involvement (UMNL/ LMNL)

Leg length discrepancy

# Causes of abnormal gait

## abnormal deformities –

- Equinus gait
- Equinovarus gait
- Calcaneal gait
- Knock & bow knee gait
- Genurecurvatum gait

## Leg Length Discrepancy (LLD) –

- Equinus gait

# Antalgic gait

This is a compensatory gait pattern adopted in order to remove or diminish the discomfort caused by pain in the LL or pelvis.

**Characteristic features:**

Decrease in duration of stance phase of the affected limb (unable of weight bear due to pain).

lack of weight shift laterally over the stance limb and also to keep weight off the involved limb.

Decrease in stance phase in affected side will result in a decrease in swing phase of sound limb.

# Gluteus maximus gait

The gluteus maximus act as a restraint for forward progression.

The trunk quickly shifts posteriorly at heel strike (*initial contact*).

This will shift the body's COG posteriorly over the gluteus maximus, moving the line of force posterior to the hip joints.

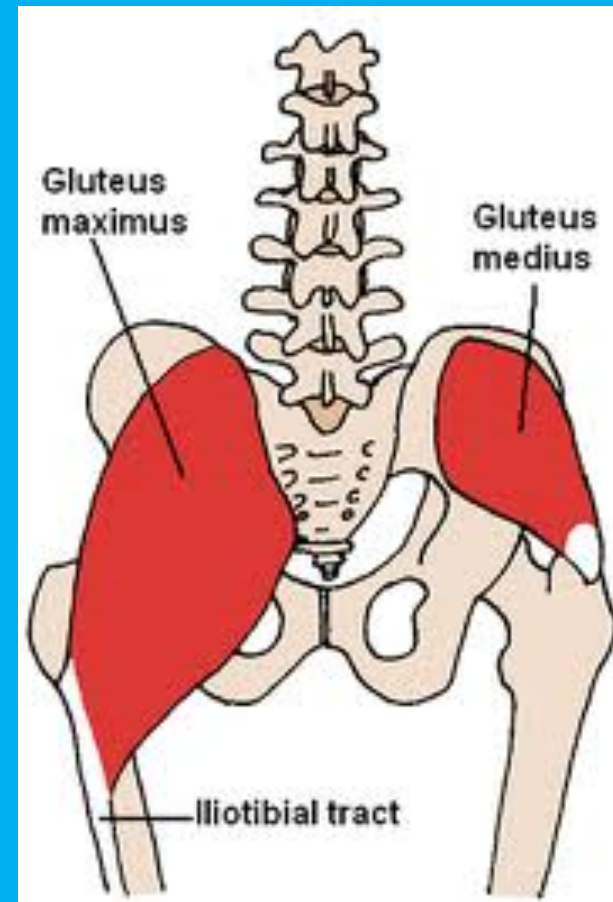

With foot in contact with floor, this requires less muscle strength to maintain the hip in extension during stance phase.

This shifting is referred to as a "Rocking Horse Gait" because of the extreme backward-forward movement of the trunk.



# Gluteus medius gait

Trendelenberg gait.

The individual shifts the trunk over the affected side during stance phase.

it cause two thing:

- The body leans over the left leg during stance phase of the left leg
- Right side of the pelvis will drop when the right leg leaves the ground & begins swing phase.



Bilateral paralysis,  
waddling or duck gait.

The patient lurch to  
both sides while  
walking.

The body sways from  
side to side on a wide  
base with excessive  
shoulder swing.

- E.g. Muscular dystrophy



# Quadriceps gait

Quadriceps action is needed during loading response and midstance when there is a flexion movement acting at the knee.

Quadriceps weakness/ paralysis will lead to buckling of the knee during gait & thus loss of balance.

Patient can compensate this if he has normal hip extensor & plantar flexors.

# Compensation:

With quadriceps weakness, the individual may lean forward over the quadriceps at the early part of stance phase, as weight is being shifted on to the stance leg.

Normally, the line of force falls behind the knee, requiring quadriceps action to keep the knee from buckling.

By leaning forward at the hip, the COG is shifted forward & the line of force now falls in front of the knee.

This will force the knee backward into extension.

Another compensatory manoeuvre to use is the hip extensors & ankle plantar flexors in a closed chain action to pull the knee into extension at heel strike (*initial contact*).

In addition, the person may physically push on the anterior thigh during stance phase, holding the knee in extension.



# Genu recurvatum gait

Hamstrings  
are weak,  
2 things  
may  
happen

- During stance phase, the knee will go into excessive hyperextension.
- During the deceleration (terminal swing) part of swing phase, without the hamstrings to slow down the swing forward of the lower leg, the knee will snap into extension.



# Foot drop or slapping gait

This is due to dorsiflexor weakness caused by paralysis of common peroneal nerve.

There won't be normal heel strike, instead the foot comes in contact with ground as a whole with a slapping sound.

So it is also known as "Slapping gait".

Due to plantarflexion of the ankle, there will be relatively lengthening at the leading extremity.

So to clear the ground the patient lift the limb too high.

Hence the gait gets its another name i.e. "High Stepping Gait"

# Equinus gait

Because of paralysis of dorsiflexor which result in plantar flexor contracture.

The patients will walk on his toes (toe walking).

Other cause may be compensation by plantar flexor for a short leg.

# Calcaneal gait

Result from paralysis plantar flexors causing dorsiflexor contracture.

The patient will be walking on his heel (heel walking)

It is characterized by greater amounts of ankle dorsiflexion & knee flexion during stance & a shorter step length on the affected side.

Single-limb support duration is shortened because of the difficulty of stabilizing the tibia & the knee.



# Unequal Leg Length

We all have unequal leg length, usually a discrepancy of *approx 1/4 inch* between the right and left legs.

Clinically, these smaller discrepancies are often corrected by inserting heel lifts of various thicknesses into the shoe.

Leg length discrepancy (LLD) are divided in –

- Minimal leg length discrepancy
- Moderate leg length discrepancy
- Severe leg length discrepancy

# Minimal LLD

Compensation occurs by dropping the pelvis on the affected side.

The person may compensate by leaning over shorter leg.

# Moderate LLD

Approx between *3 & 5 cm*, dropping the pelvis on the affected side will no longer be effective.

A longer leg is needed, so the person usually walks on the ball of the foot on the involved (shorter) side.

This is called an "Equinus Gait".

# Severe LLD

It is usually discrepancy of *more than 5 cm.*

The person may compensate in a variety of ways.

Dropping the pelvis and walking in an equinus gait plus flexing the knee on the uninvolved side is often used.

# hemiplegic gait

With spastic pattern of hemiplegic leg

- Hip into extension, adduction & medial rotation
- Knee in extension, though often unstable
- Ankle in drop foot with ankle plantar flexion and inversion (equinovarus), which is present during both stance and swing phases.

In order to clear the foot from the ground the hip & knee should flex.



Spastic muscles won't allow the hip & knee to flex for the floor clearance.

The patient hikes hip & bring the affected leg by making a half circle i.e. circumducting the leg.

Hence the gait is known as "Circumductory Gait".

Usually, there will be no reciprocal arm swing.

Step length tends to be lengthened on the involved side & shortened on the uninvolved side.

# Scissoring gait

It results from spasticity of bilateral adductor muscle of hip.

One leg crosses directly over the other with each step like crossing the blades of a scissor.

- E.g. Cerebral Palsy



# Dragging or paraplegic gait



There is spasticity of both hip & knee extensors & ankle plantar flexors.

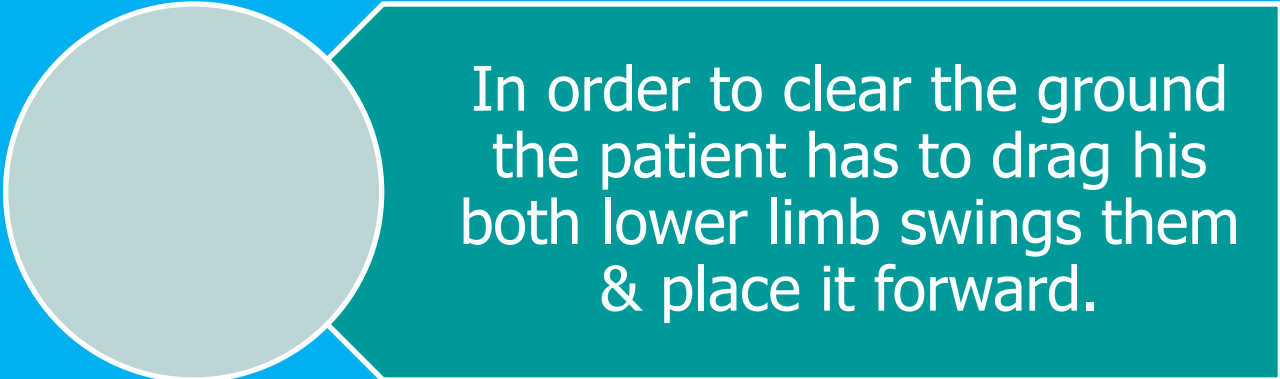

In order to clear the ground the patient has to drag his both lower limb swings them & place it forward.



# Cerebral Ataxic gait

Abnormal function of cerebellum result in a disturbance of normal mechanism controlling balance & therefore patient walks with wider BOS.

The wider BOS creates a larger side to side deviation of COG.

This result in irregularly swinging sideways to a tendency to fall with each steps.

Hence it is known as "Reeling Gait".

# Sensory ataxic gait

This is a typical gait pattern seen in patients affected by tabes dorsalis.

It is a degenerative disease affecting the posterior horn cells & posterior column of the spinal cord.

Because of lesion, the proprioceptive impulse won't reach the cerebellum.

The patient will lose his joint sense & position for his limb on space.

Because of loss of joint sense, the patient abnormally raises his leg (high step) jerks it forward to strike the ground with a stamp.

So it is also called as "Stamping Gait".

The patient compensated this loss of joint position sense by vision.

So his head will be down while he is walking.

# Short shuffling or festinate gait

Because of rigidity, all the joint will go for a flexion position with spine stooping forward.

This posture displaces the COG anteriorly.

So in order to keep the COG within the BOS, the patient will do small shuffling steps.

Due to loss of voluntary control over the movement, they loses balance & walks faster as if he is chasing the COG.

So it is called as "Festinate Gait".

Since his shuffling steps, it is otherwise called as "Shuffling Gait".

