

# Sex Linkage and X-Inactivation

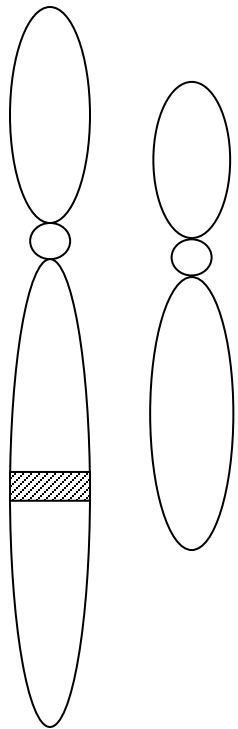

$X^A Y$

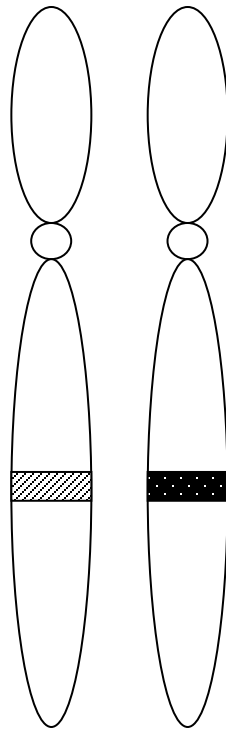

$X^A X^a$

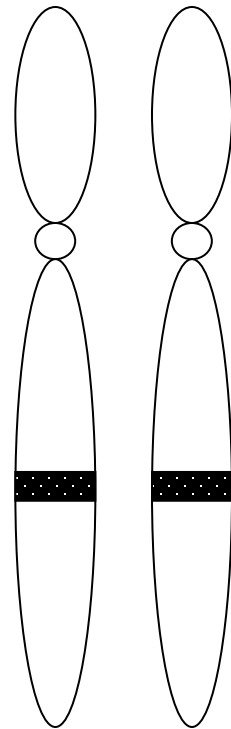

$X^a X^a$

# Dosage compensation

1. For autosomal traits, two doses lead to a normal phenotype, while one dose or more than two doses often have clinical significance
2. For X-linked traits two doses in females and one dose in males both lead to a normal phenotype

# X-inactivation in females allows compensation for this difference in dosage for X-linked traits

- Lyon hypothesis
- In early embryonic life (3-7 days after fertilization) one X chromosome is inactivated. The inactive X chromosome is condensed in a Barr body.
- Inactivation of the maternal or paternal X chromosome is random, but once it occurs, the same X will be inactive in all descendants of a particular cell.
- Some genes on the inactive X chromosome remain active, i.e., escape inactivation. These include the genes in the pseudoautosomal region that have matching genes on the Y chromosome, genes outside the pseudoautosomal region that have related copies on the Y chromosomes, and others.

# X-Inactivation

- Allows dosage compensation between males and females for genes on the X chromosome
- In females, early in embryonic life, one of the X chromosomes is inactivated
- The process is random and clonal
- Some genes escape X-inactivation

# X Inactivation in Female Mammals

- In mammalian females, one of the two X chromosomes in each cell is randomly inactivated during embryonic development
- The inactive X condenses into a **Barr body**
- If a female is heterozygous for a particular gene located on the X chromosome, she will be a mosaic for that character

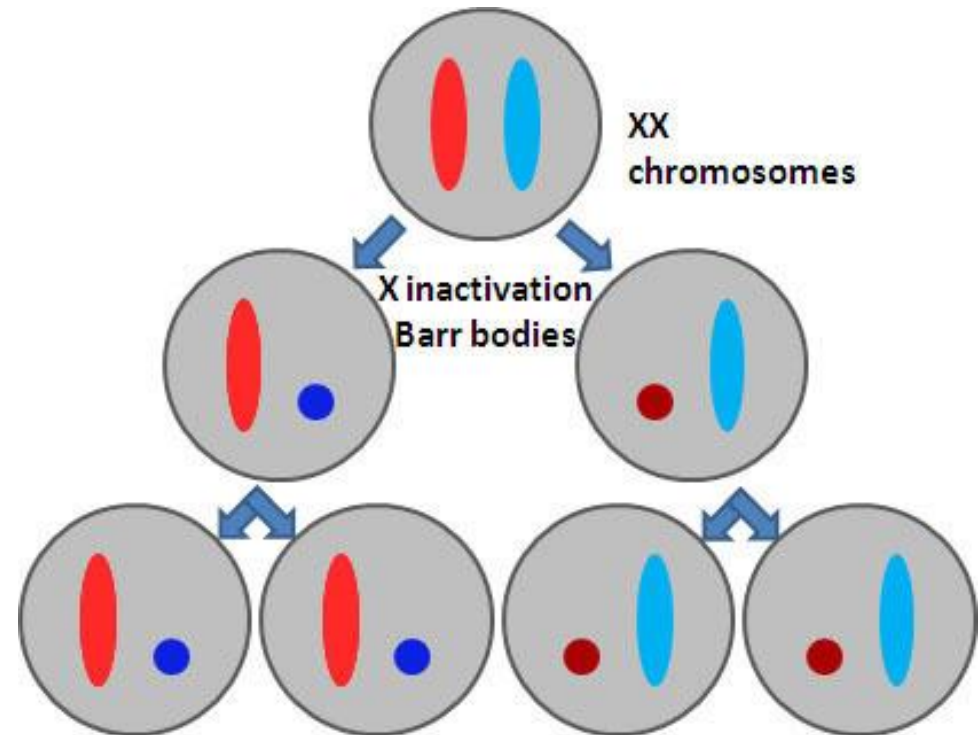

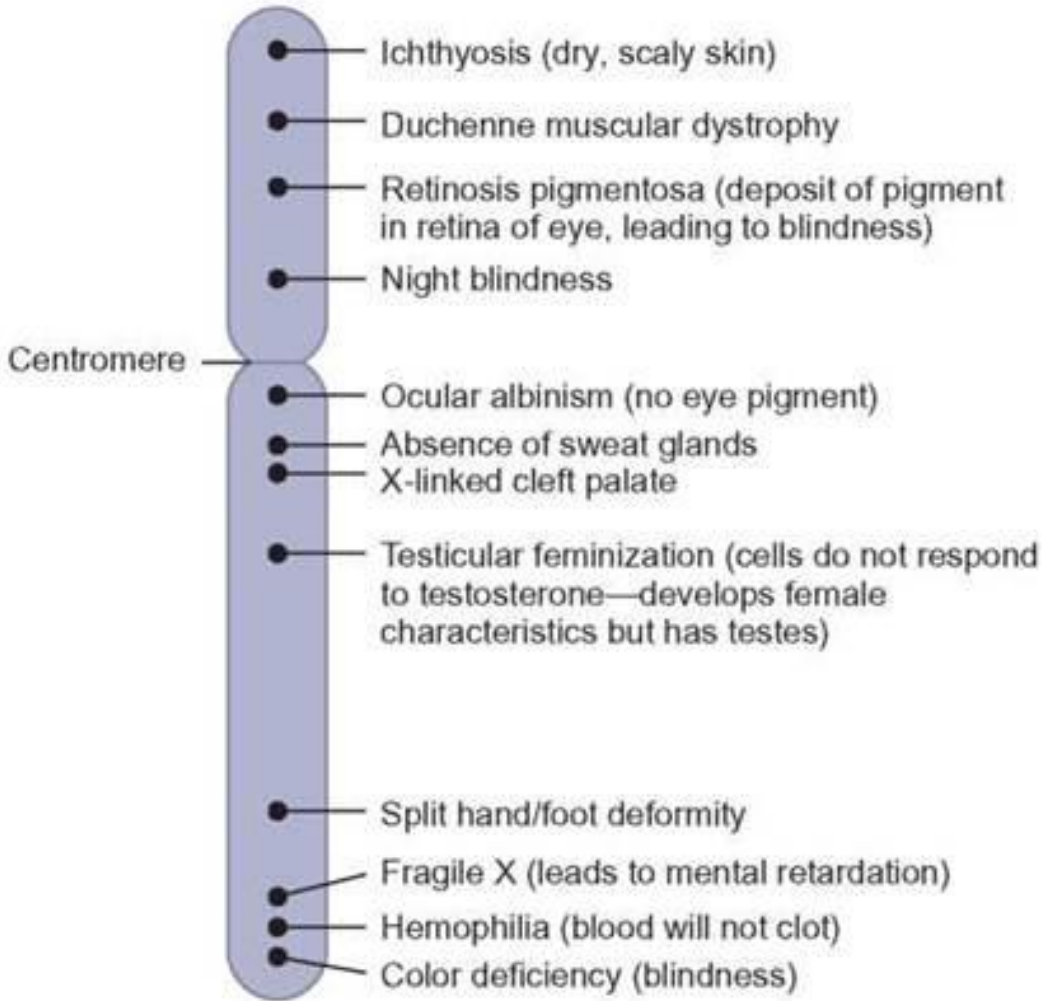

X chromosome

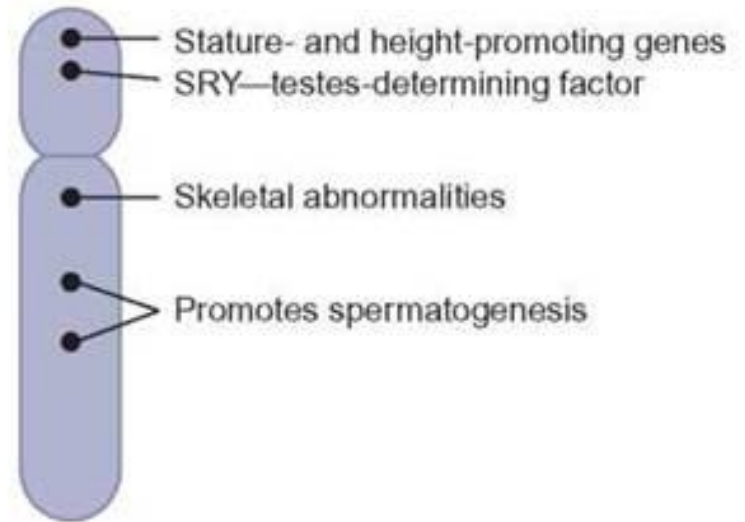

Y chromosome

- A gene that is located on either sex chromosome is called a **sex-linked gene**
- Genes on the Y chromosome are called Y-linked genes; there are **few** of these
- Genes on the X chromosome are called **X-linked genes**

# Inheritance of X-Linked Genes

- X chromosome have genes for many characters **unrelated** to sex, whereas the Y chromosome mainly encodes genes **related** to sex determination



- X-linked genes follow specific patterns of inheritance
- For a recessive X-linked trait to be expressed
  - A female needs two copies of the allele (**homozygous**)
  - A male needs only one copy of the allele (**hemizygous**)
- X-linked recessive disorders are much **more** common in males than in females

Figure 15.7

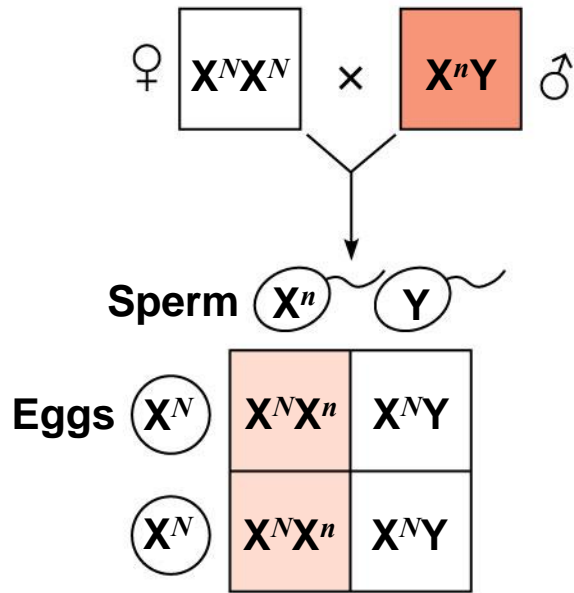

(a)

© 2011 Pearson Education, Inc.

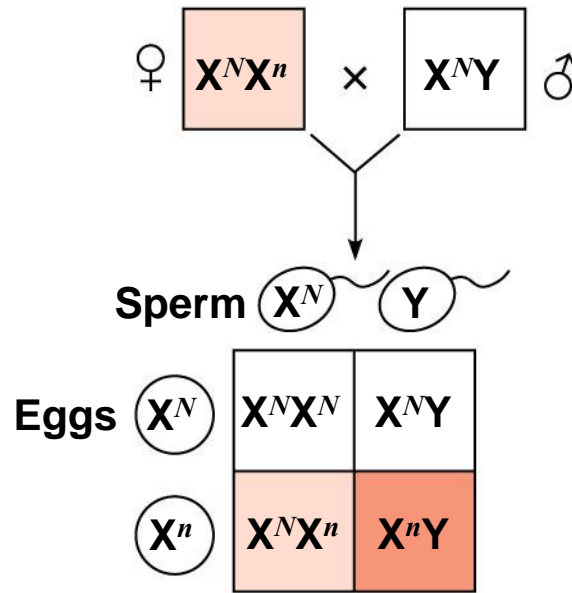

(b)

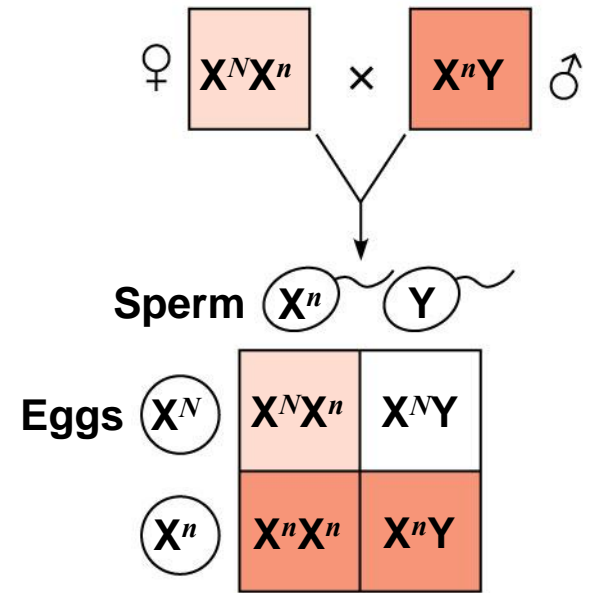

(c)

- Some disorders caused by recessive alleles on the X chromosome in humans
  - Color blindness (mostly X-linked) (**Red-green color blindness**)
  - **Duchenne muscular dystrophy** (**dystrophy** muscle weakness and loss of muscle tissue)
  - **Hemophilia**

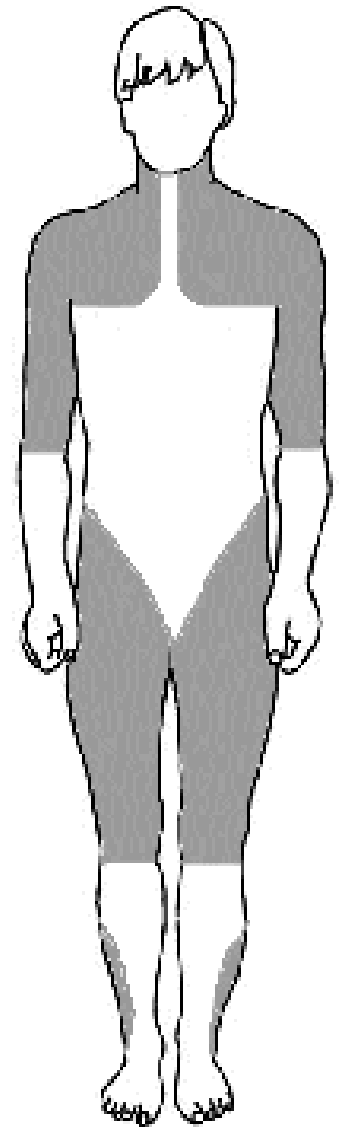

Duchenne and  
Becker Types

# Ishihara Test For Color Blindness

What People With Regular Vision See

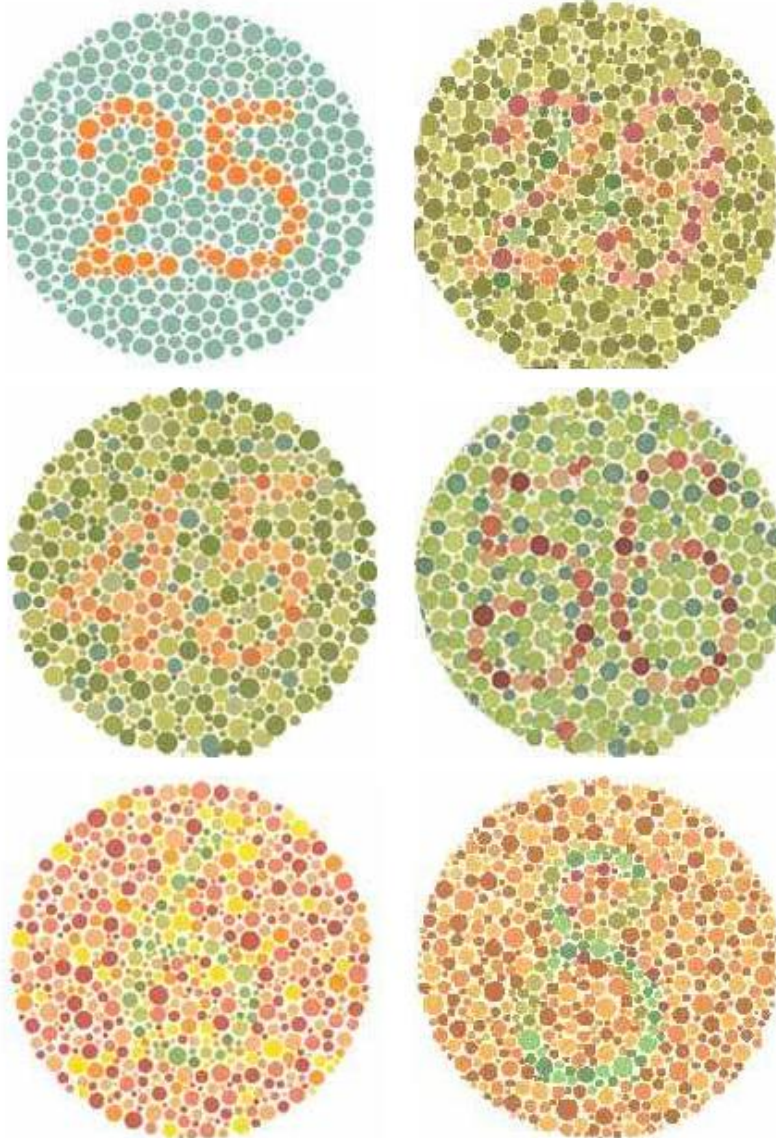

What Red-Green Color Blind People See

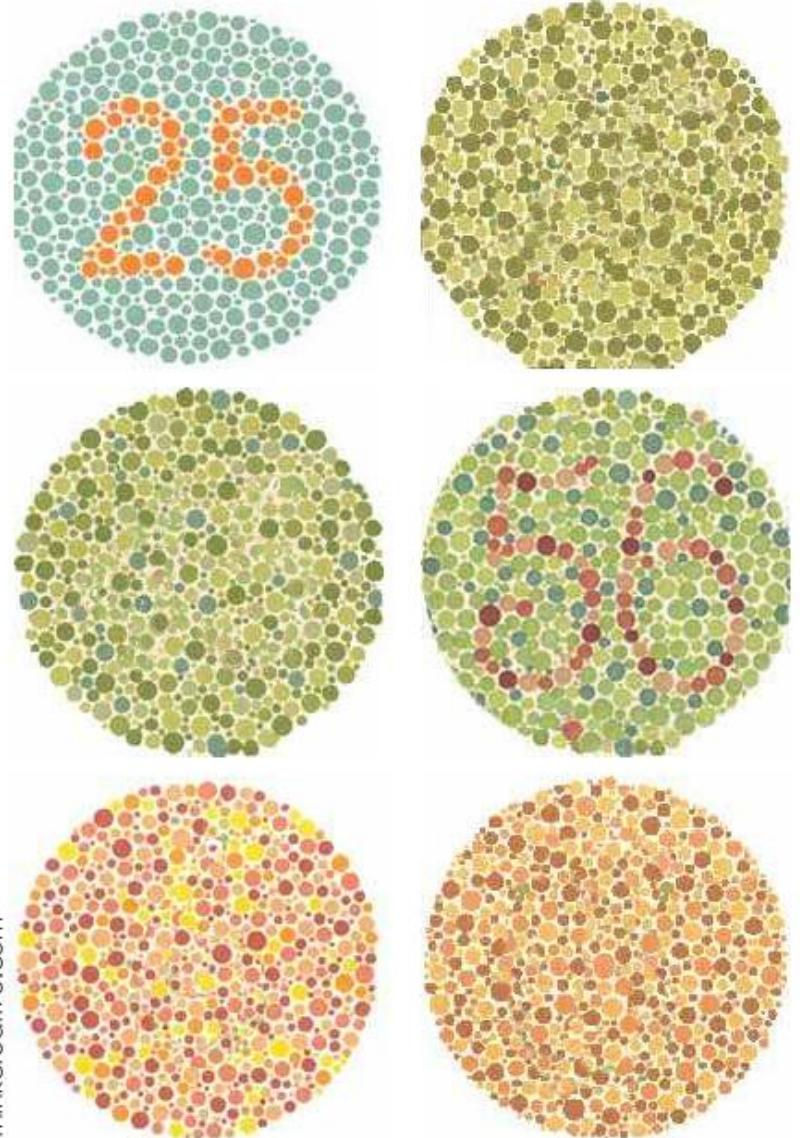

# Examples and Features of X-Linked Recessive Inheritance

Examples:

## X-Linked Recessive

### HEMOPHILIA A

Coagulation disorder  
Prolonged bleeding  
Easy bruising  
Hemorrhage  
Various mutations & very heterogeneous

### DUCHENNE MUSCULAR DYSTROPHY

Progressive muscle weakness  
Death typically in 2nd or 3rd decade  
30% cases due to new mutation  
**Allelic heterogeneity (Becker MD)**



# Duchenne muscular dystrophy



Figure 1.4. A 15-year-old boy with Duchenne muscular dystrophy

# X-Linked Recessive Pedigree

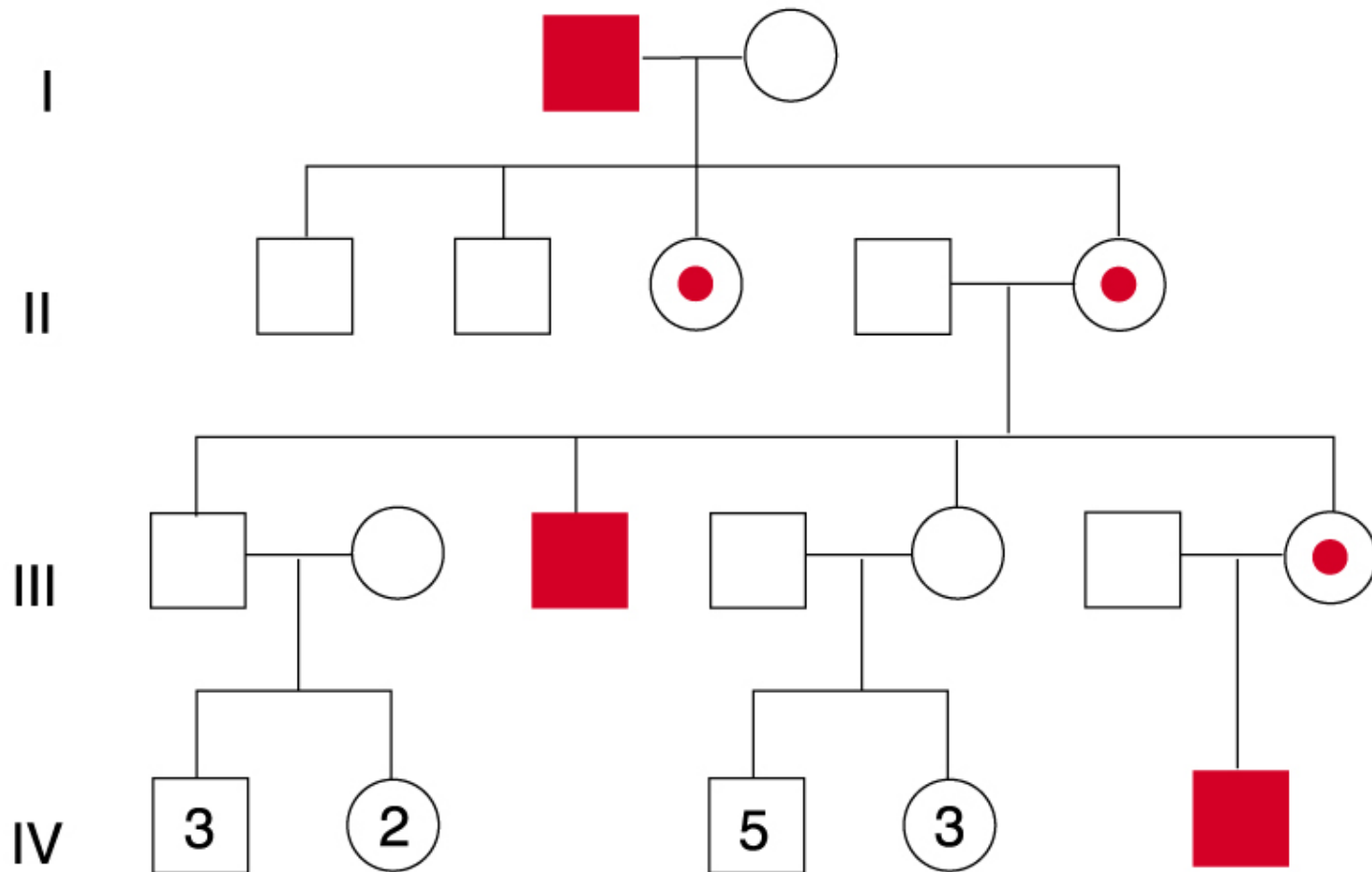

# Features of X-Linked Recessive Inheritance

1. Diagonal inheritance – affected males related through females of the maternal line
2. Absence of male-to-male transmission
3. Incidence of trait much higher in males than females
4. Full expression in hemizygous males
5. No or mild expression in carrier females due to X-inactivation



# Transmission probabilities and use of the Punnett square

1. A son never inherits the disorder from his father.
2. All daughters of a male with the disorder are obligate carriers.
3. Sons of carrier females have a 50% chance of inheriting the disorder.
4. Daughters of carrier females have a 50% chance of being carriers too.

## X-Linked Recessive Inheritance

(Affected Father)

		Paternal Gametes	
		$X^a$	Y
Maternal Gametes	$X^A$	$X^A X^a$	$X^A Y$
	$X^A$	$X^A X^a$	$X^A Y$

A = normal, a = mutant

1 carrier female : 1 normal male

## X-Linked Recessive Inheritance

(Carrier Mother)

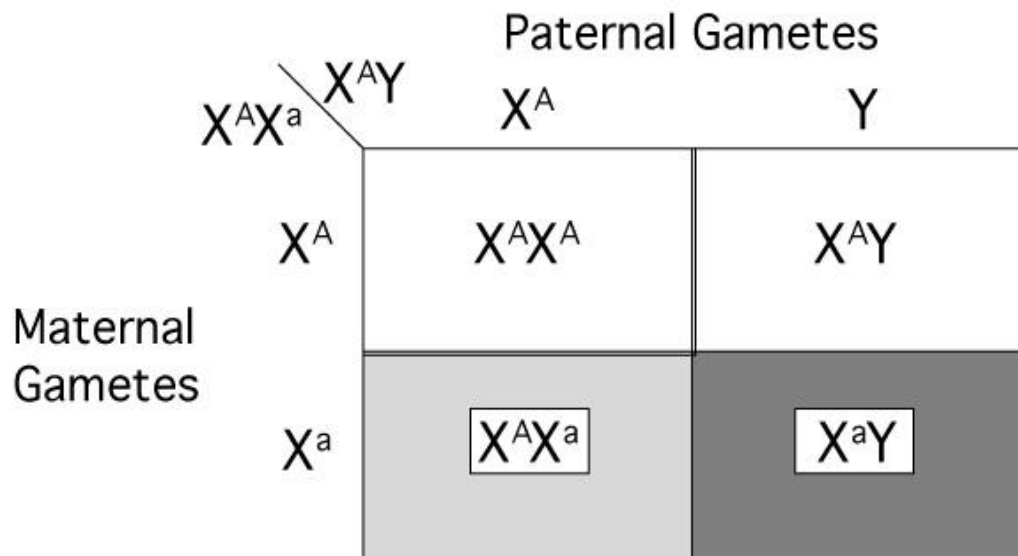

A = normal, a = mutant

1 normal female : 1 carrier female : 1 normal male : 1 affected male

# Examples and Features of X-Linked Dominant Inheritance



X-linked Dominant

VITAMIN D RESISTANT  
RICKETS

Rickets  
Short stature  
Low serum phosphate  
Less severe in heterozygous females

# X-Linked Dominant Pedigree

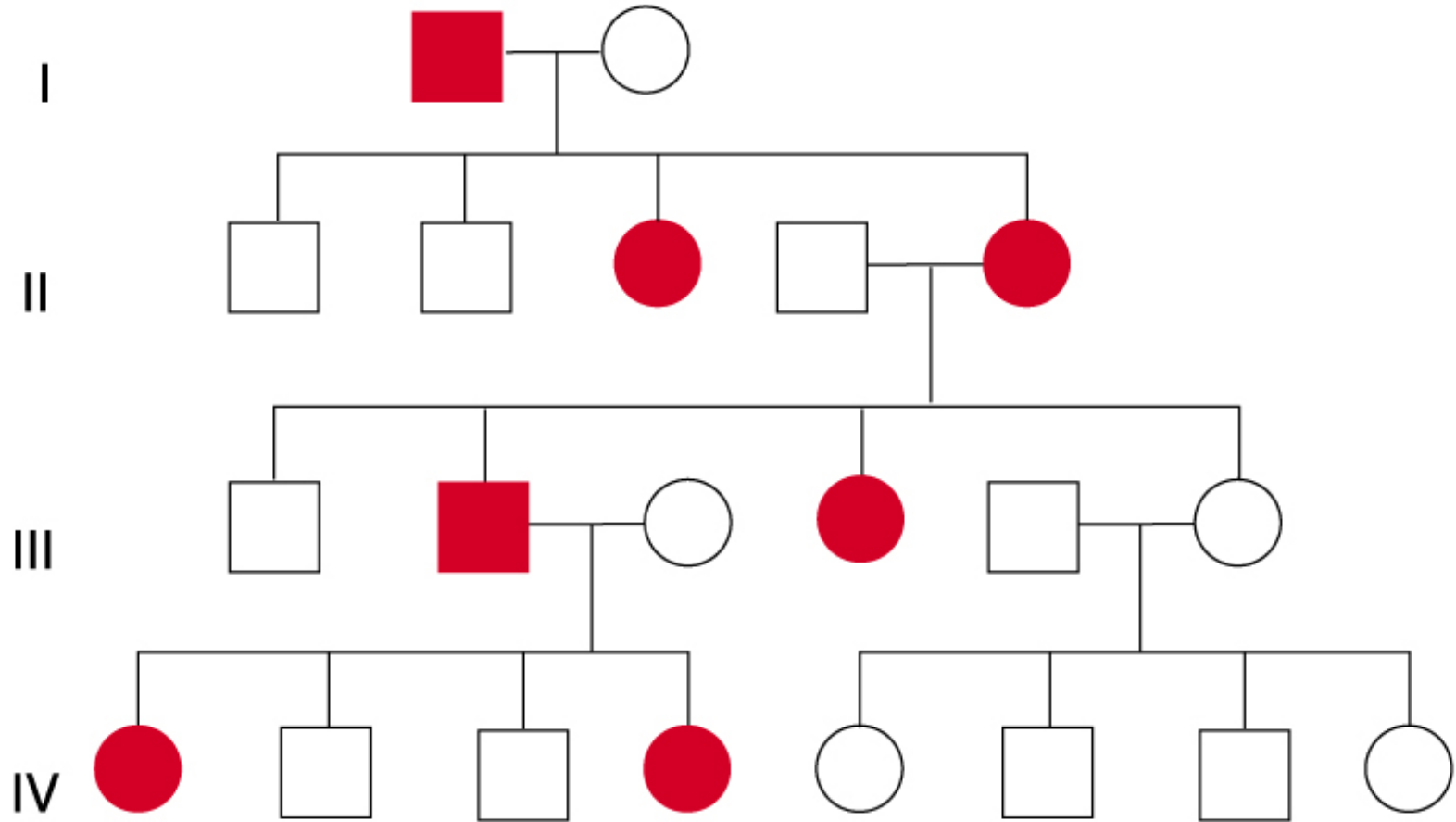

# Features of X-Linked Dominant Inheritance

1. Twice as many females with the disorder as males
2. Absence of male-to-male transmission
3. Males with the disorder transmit it to all daughters and no sons
4. Females usually have more mild and variable expression due to X-inactivation
5. Few disorders classified as X-linked dominant

# Transmission probabilities and use of the Punnett square

1. A son never inherits the disorder from his father
2. All daughters of male with the disorder will also have the disorder
3. Sons of affected females have a 50% chance of inheriting the disorder
4. Daughters of affected females also have a 50% chance of inheriting the disorder
5. Can distinguish between autosomal and X-linked dominant by looking at offspring of affected males

## X-Linked Dominant Inheritance

(Affected Mother)

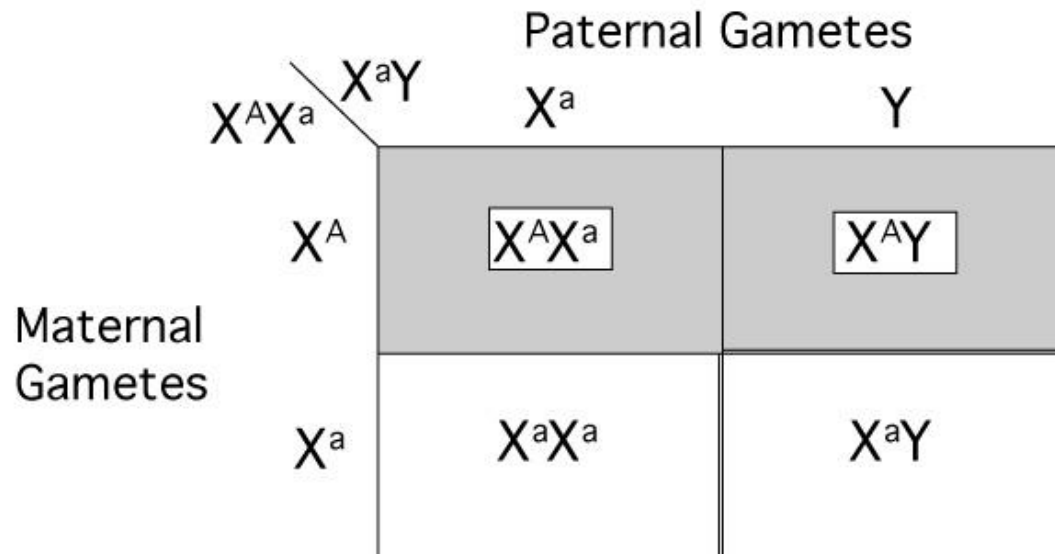

A = mutant, a = normal

1 normal female : 1 normal male : 1 affected female : 1 affected male



# Pedigree Practice

What is the mode of inheritance?

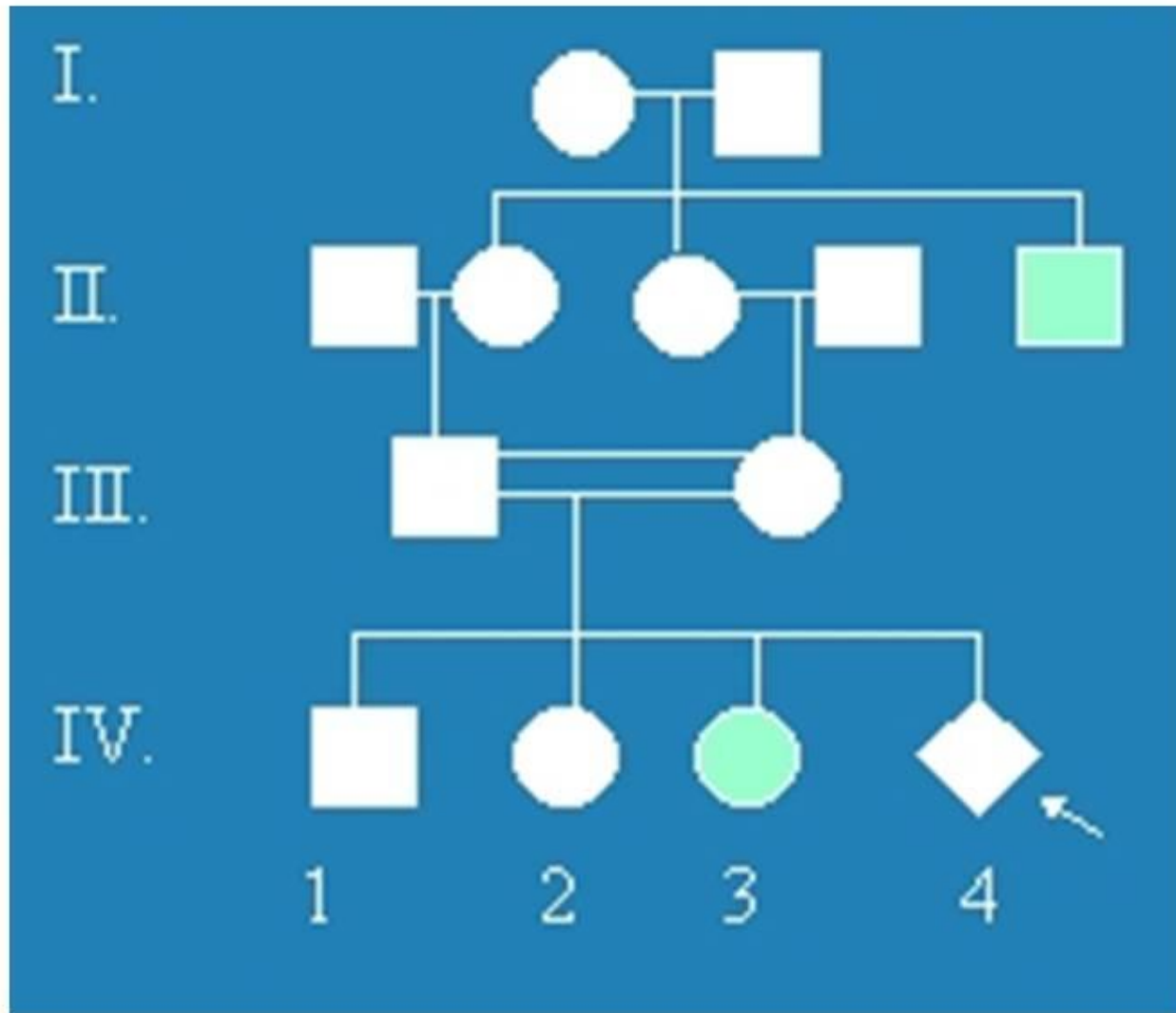

What is the mode of inheritance?

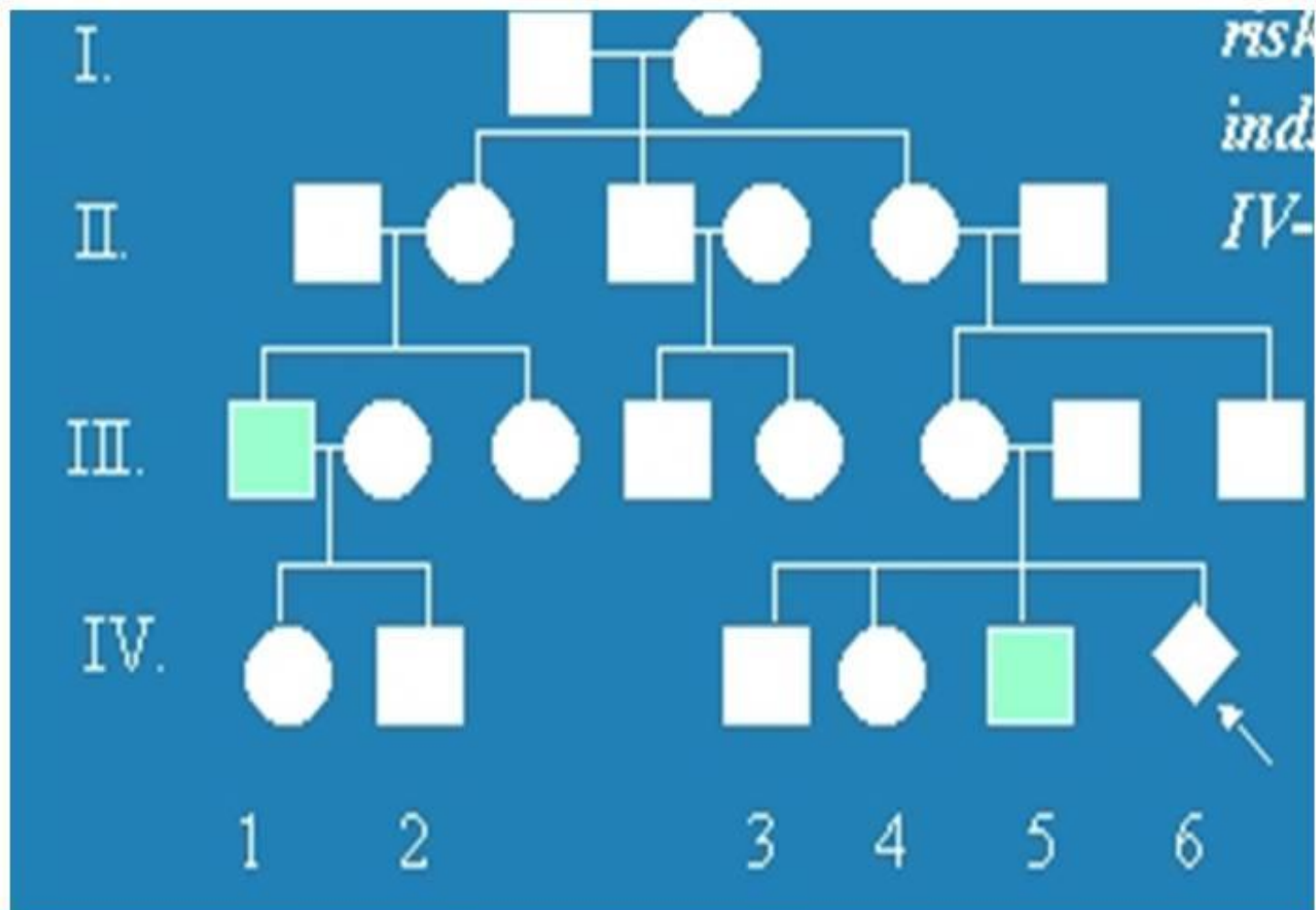

# What is the mode of inheritance?

Y-linked

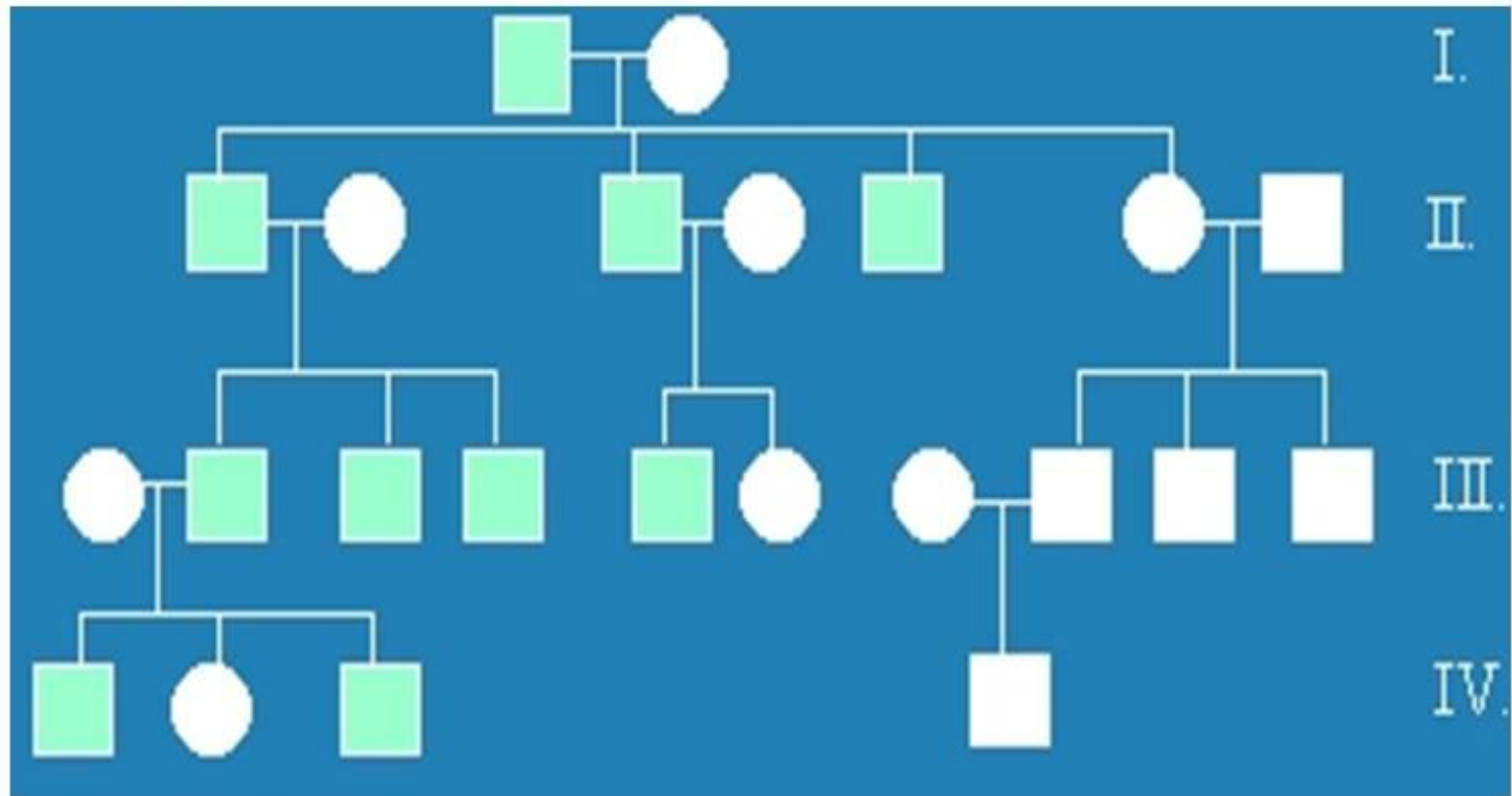

What is the mode of inheritance?

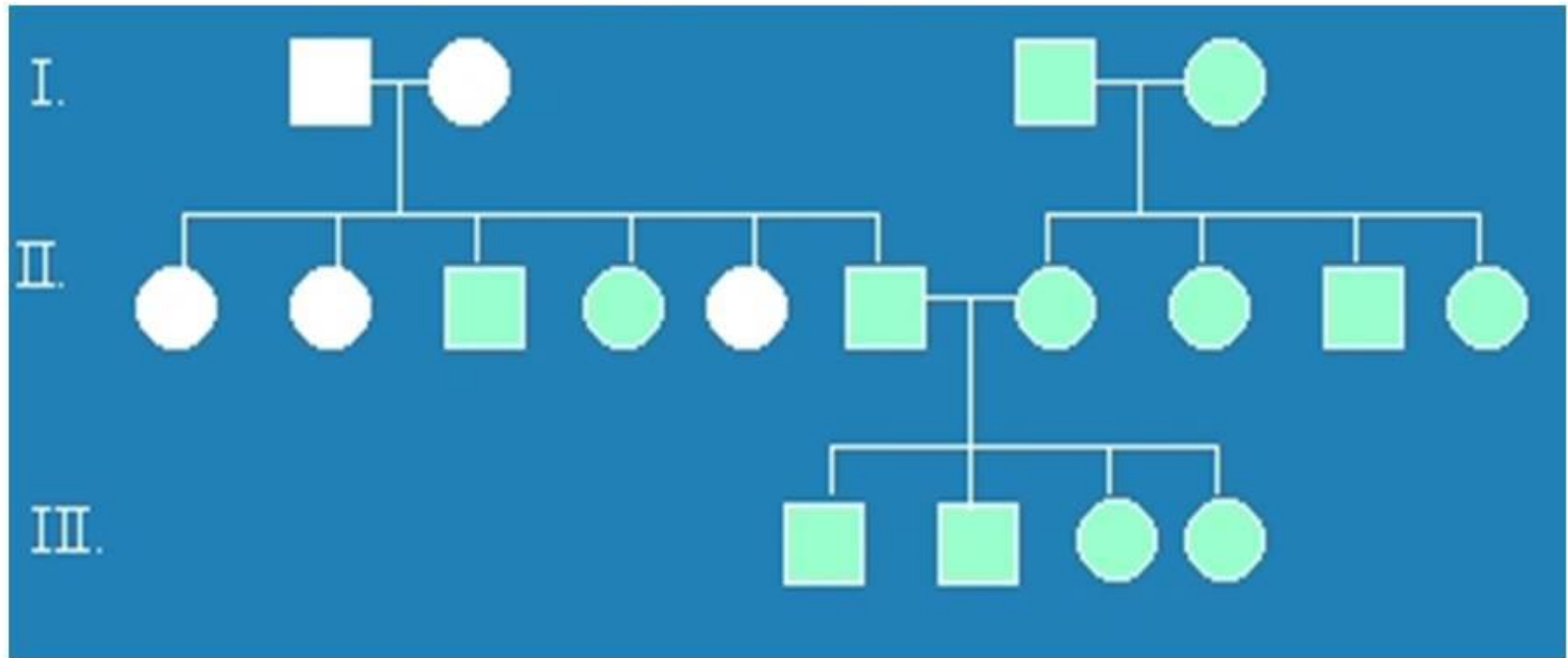

# What is the mode of inheritance?

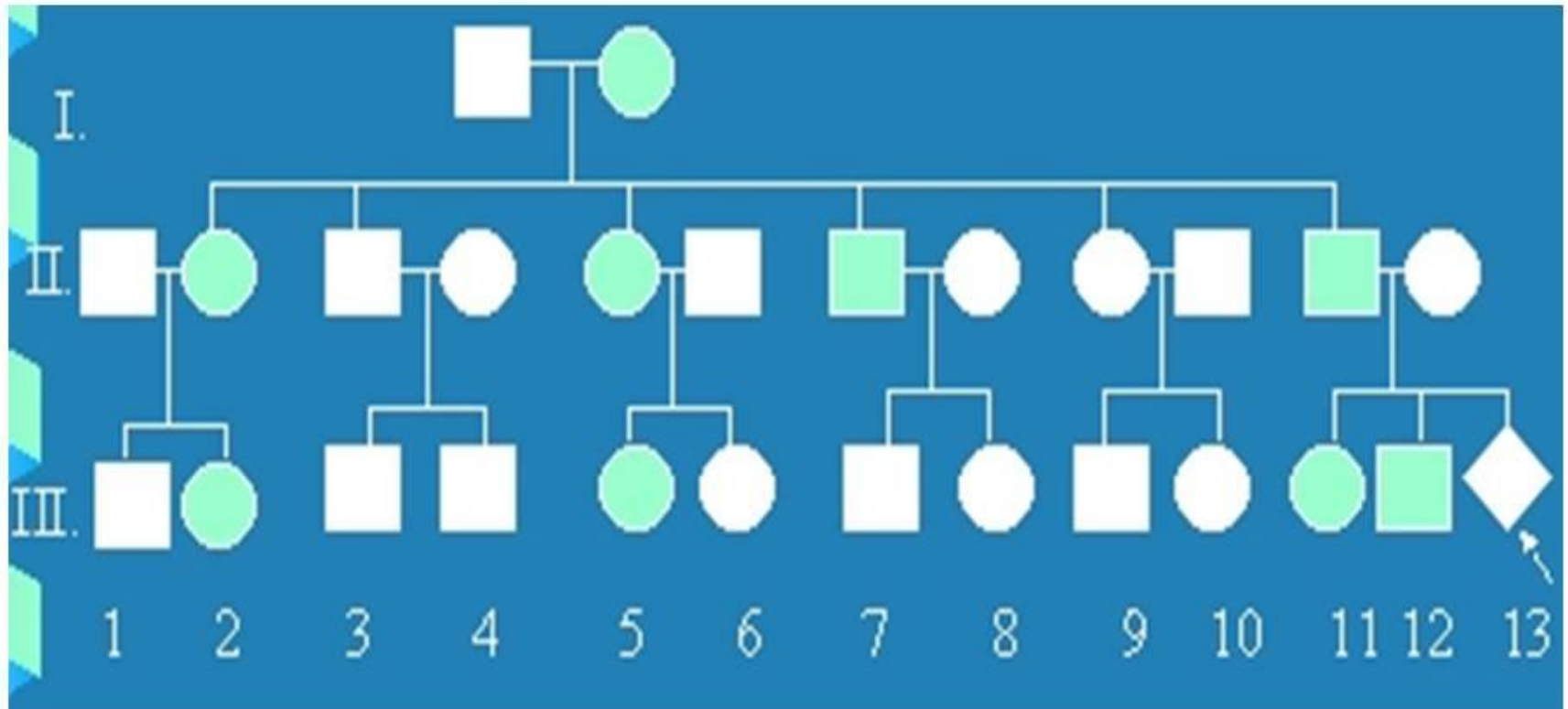

# What is the mode of inheritance?

X-linked recessive; inbreeding shows apparent male to male transmission

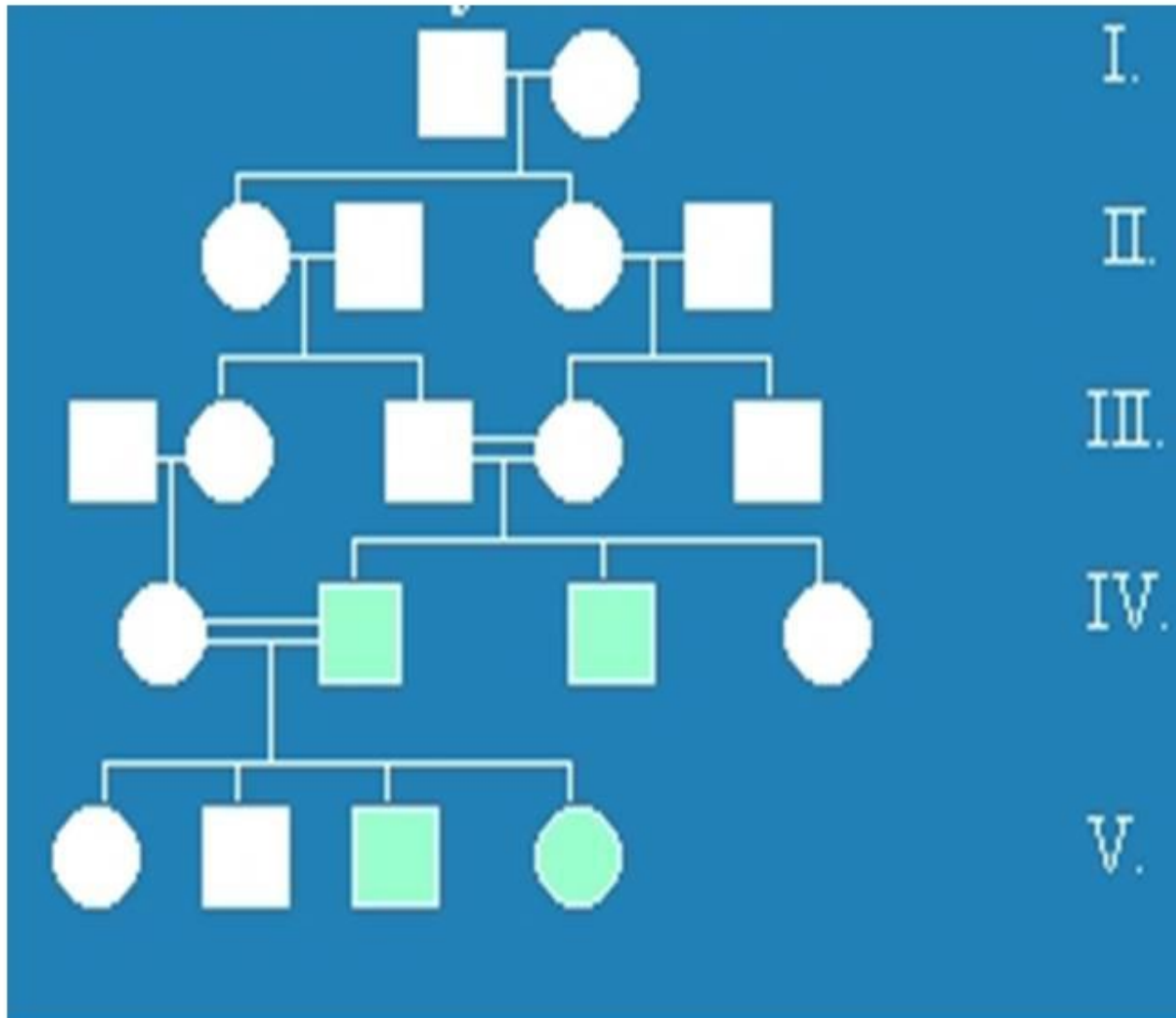

What is the mode of inheritance?

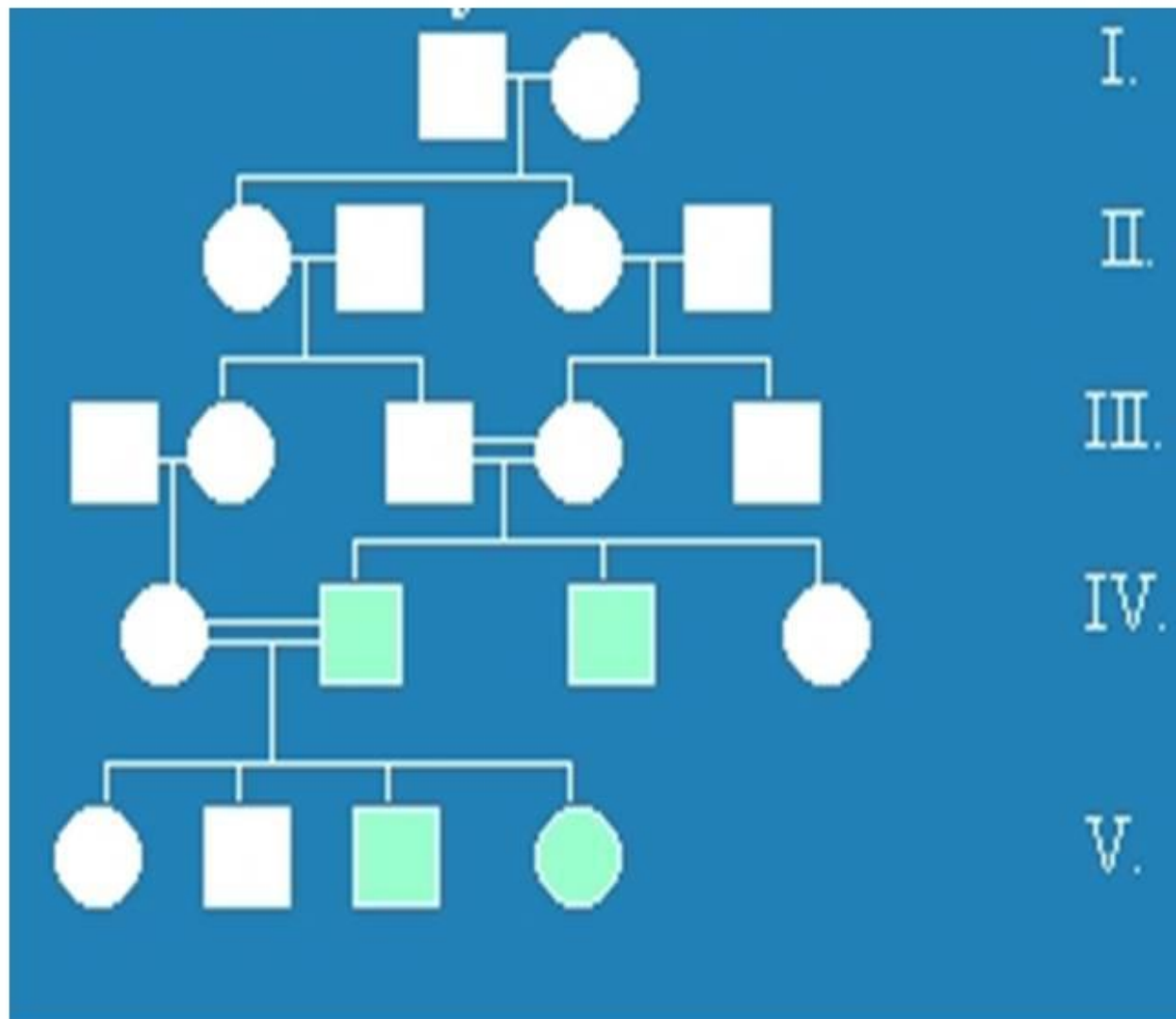



# What is the mode of inheritance?

Autosomal recessive

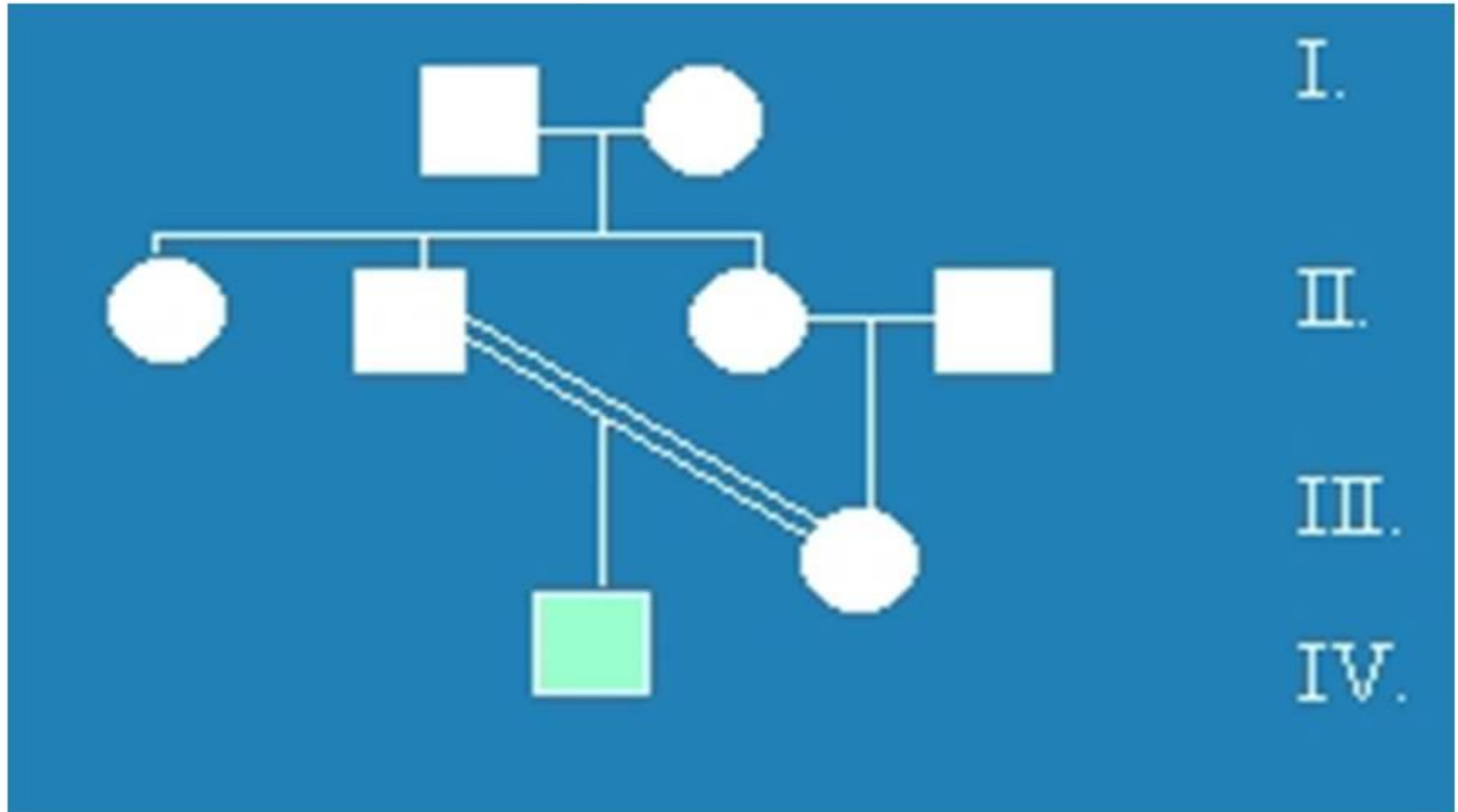

What is the mode of inheritance?

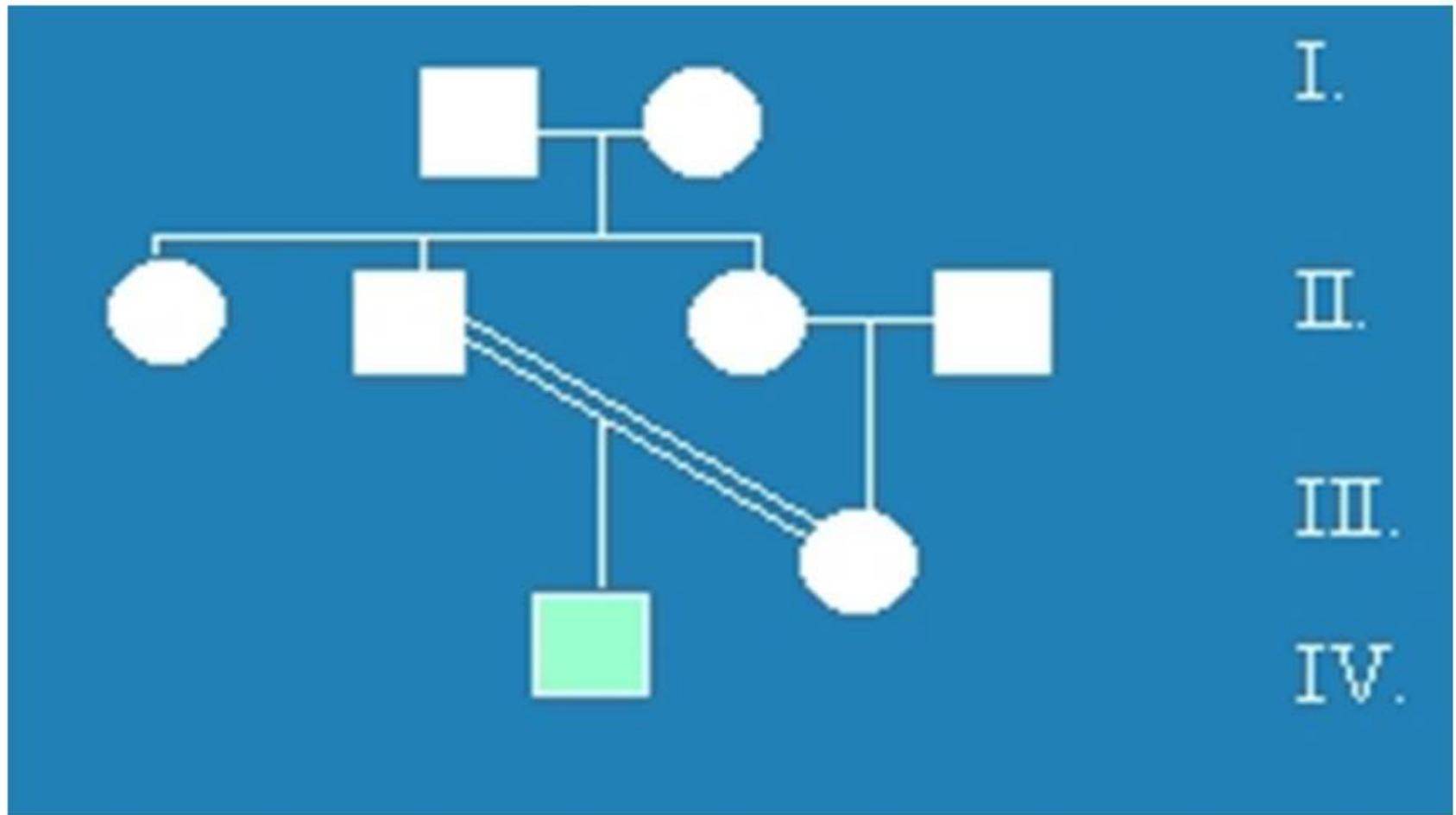

# What is the mode of inheritance?

Autosomal dominant

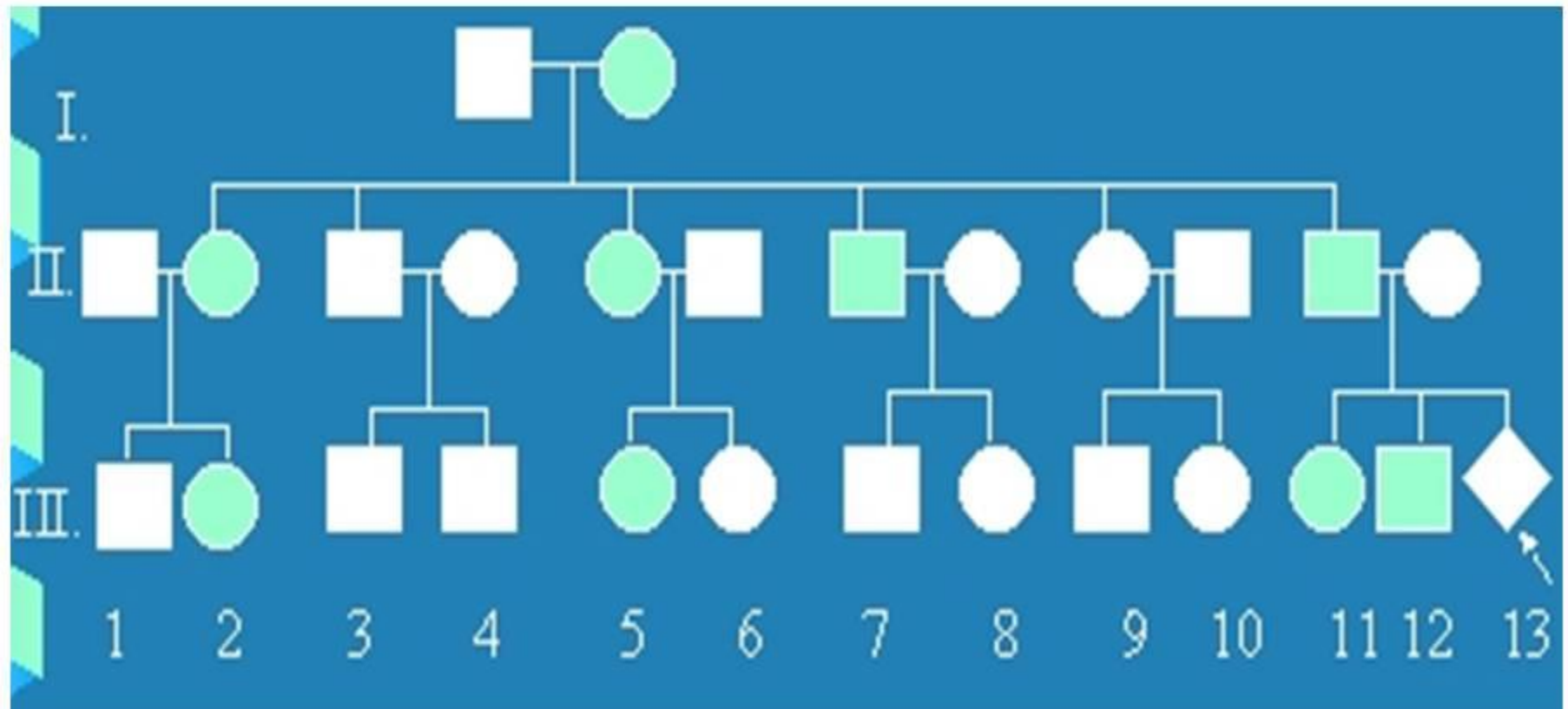

What is the mode of inheritance?

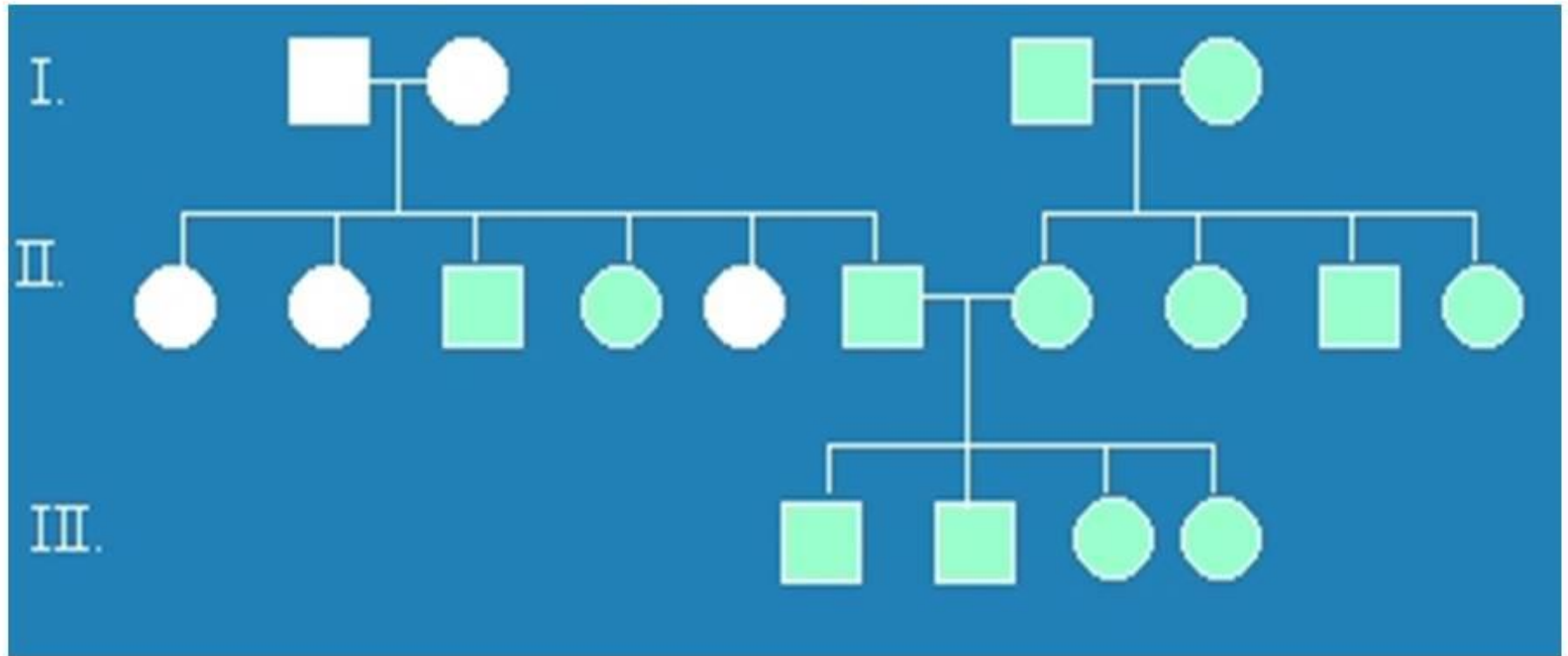

What is the mode of inheritance?

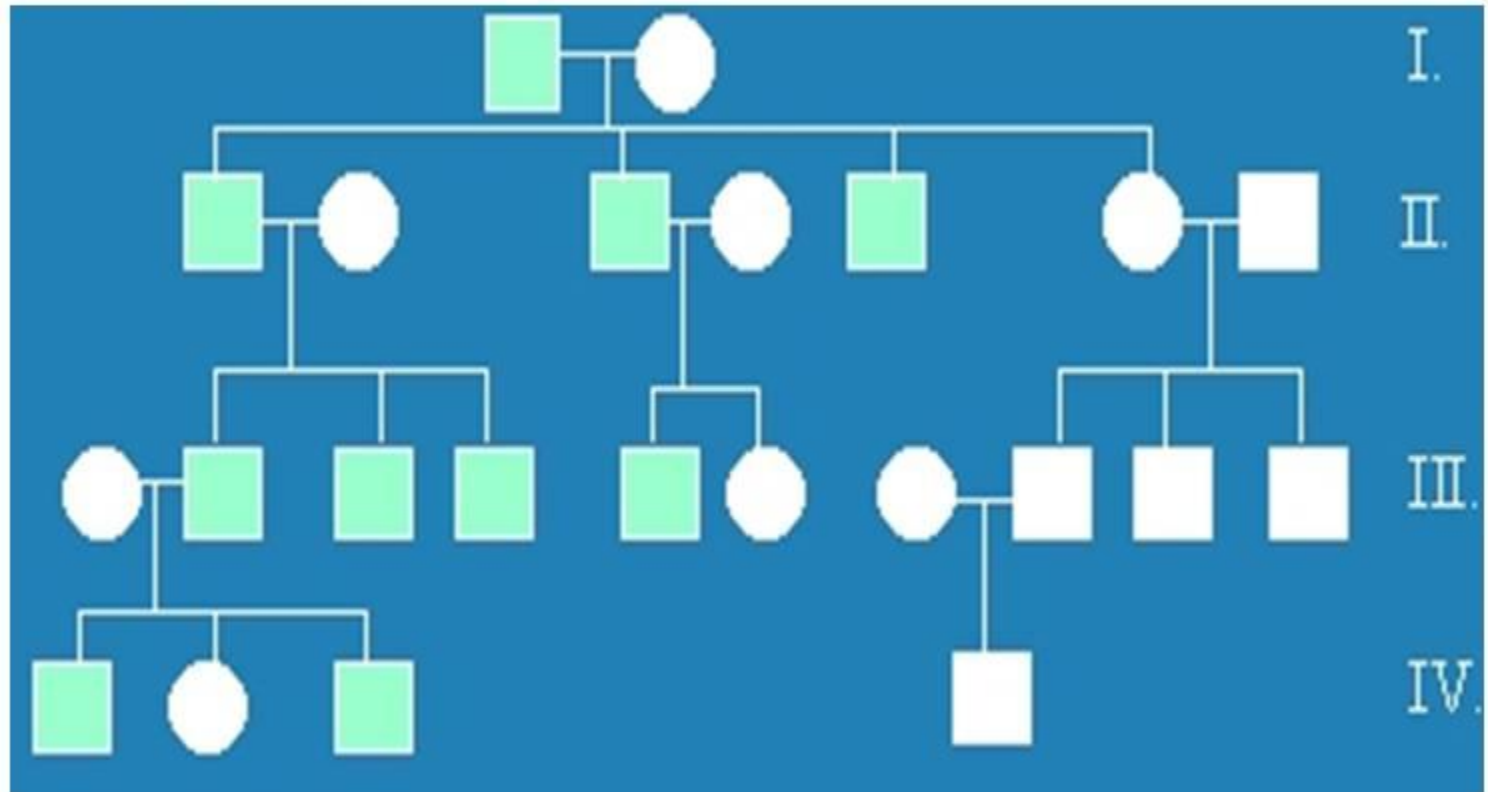

# What is the mode of inheritance?

X-linked recessive

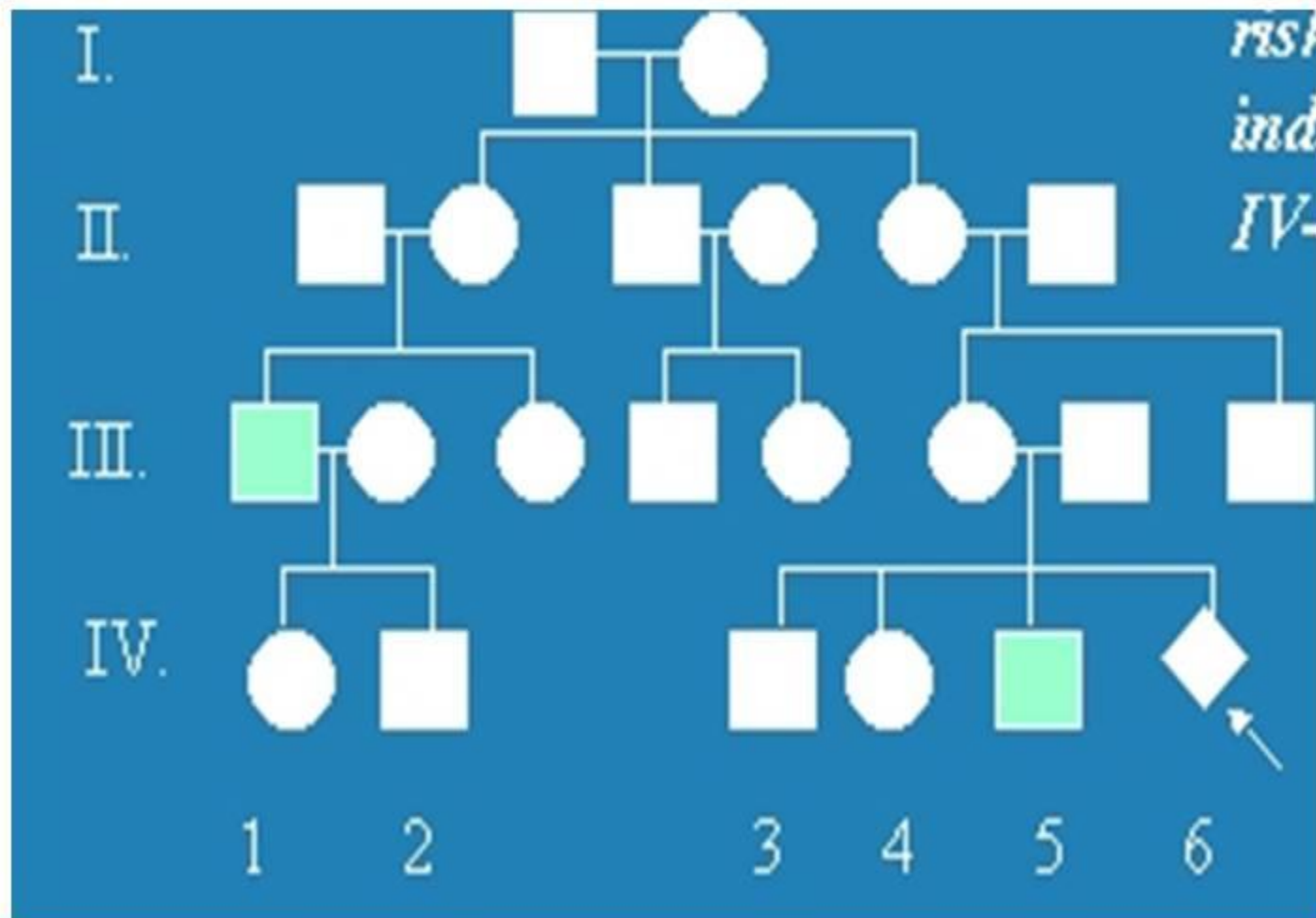

# What is the mode of inheritance?

Autosomal recessive

