

GUYTON AND HALL *Textbook of*
Medical Physiology

TWELFTH EDITION

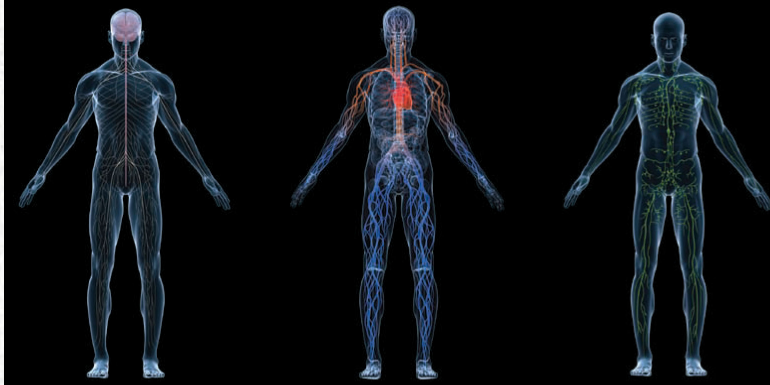

Chapter 27:

Urine Formation by the Kidneys:
II. Tubular Reabsorption and Secretion

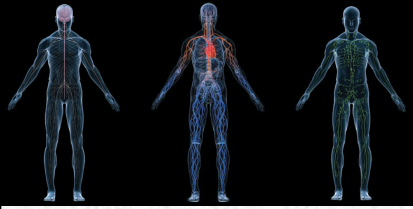

The functional unit of the kidney

Basic Mechanisms of Urine Formation

- Ultrafiltration
- Reabsorption
- Secretion
- Excretion

**Excretion =
Filtration - Reabsorption +
Secretion**

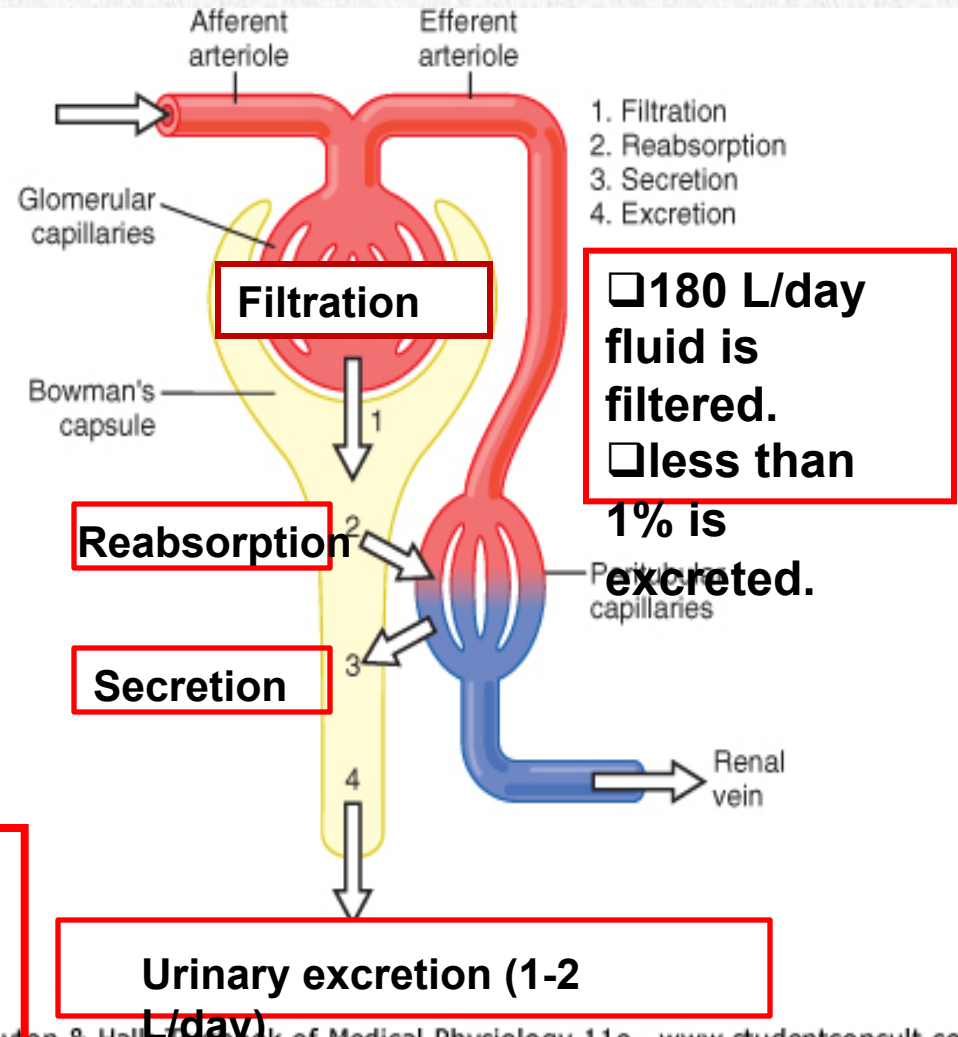

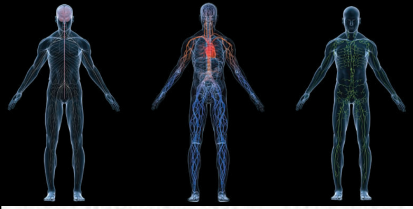

Reabsorption of Water and Solutes

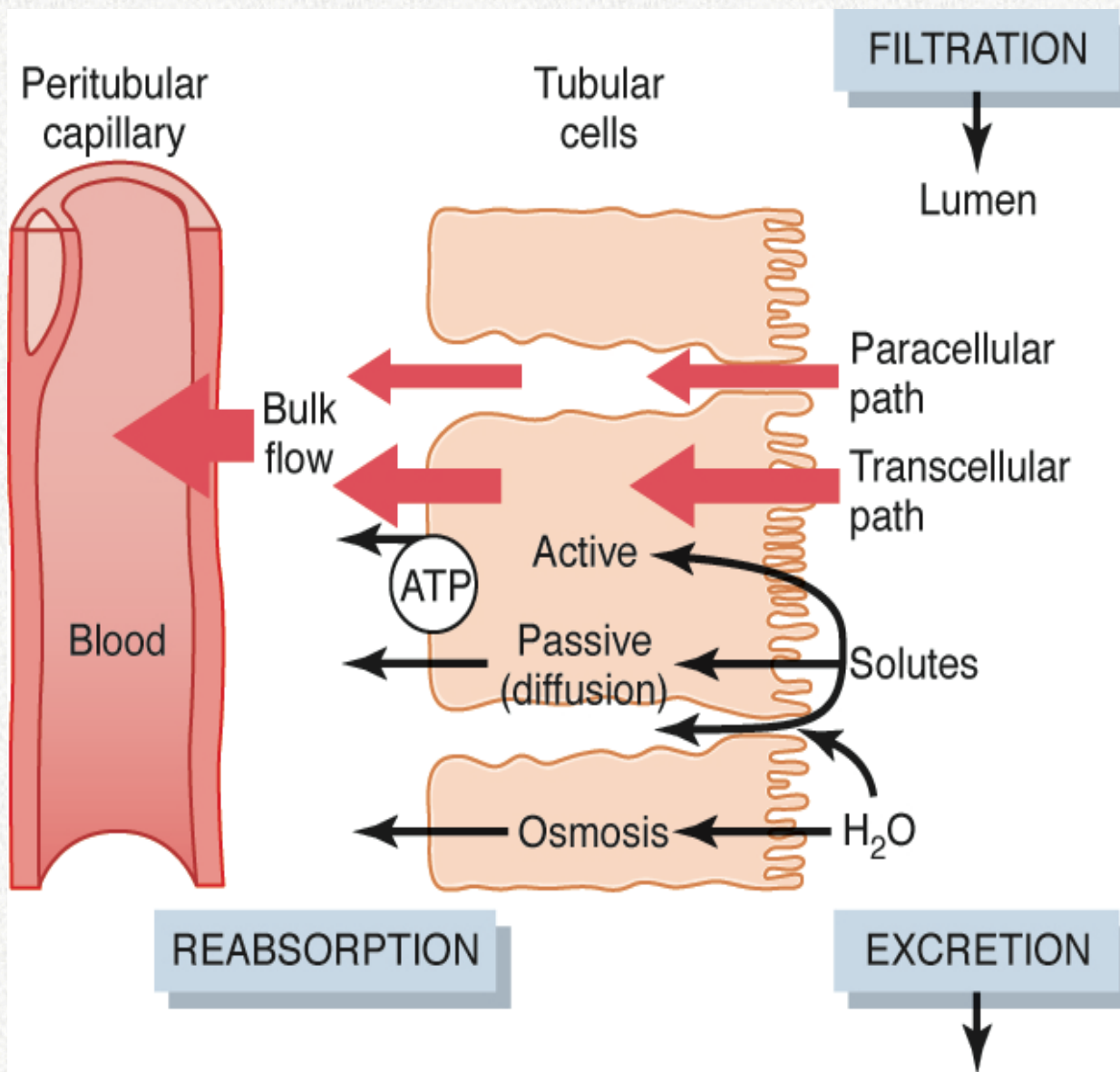

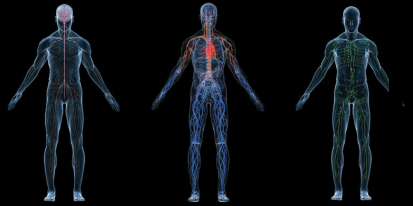

Reabsorption of Water and Solutes

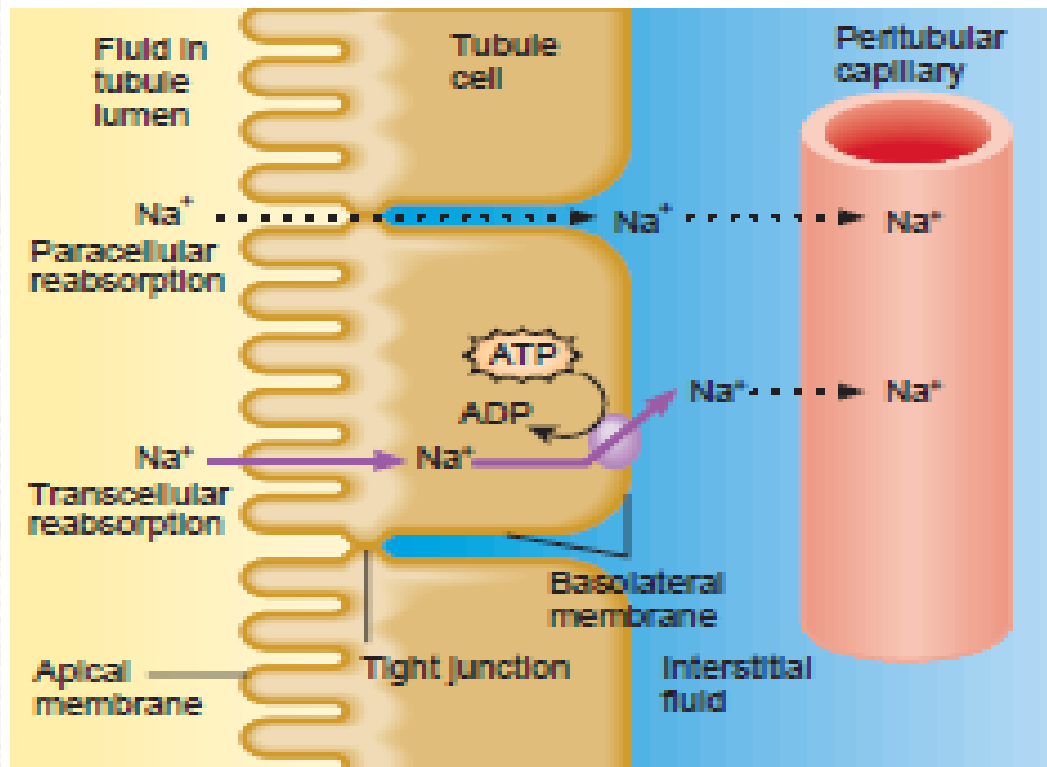

Key:

.....▶ Diffusion

————▶ Active transport

 Sodium-potassium pump (Na⁺K⁺ATPase)

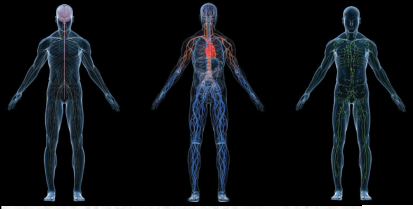

Active Transport

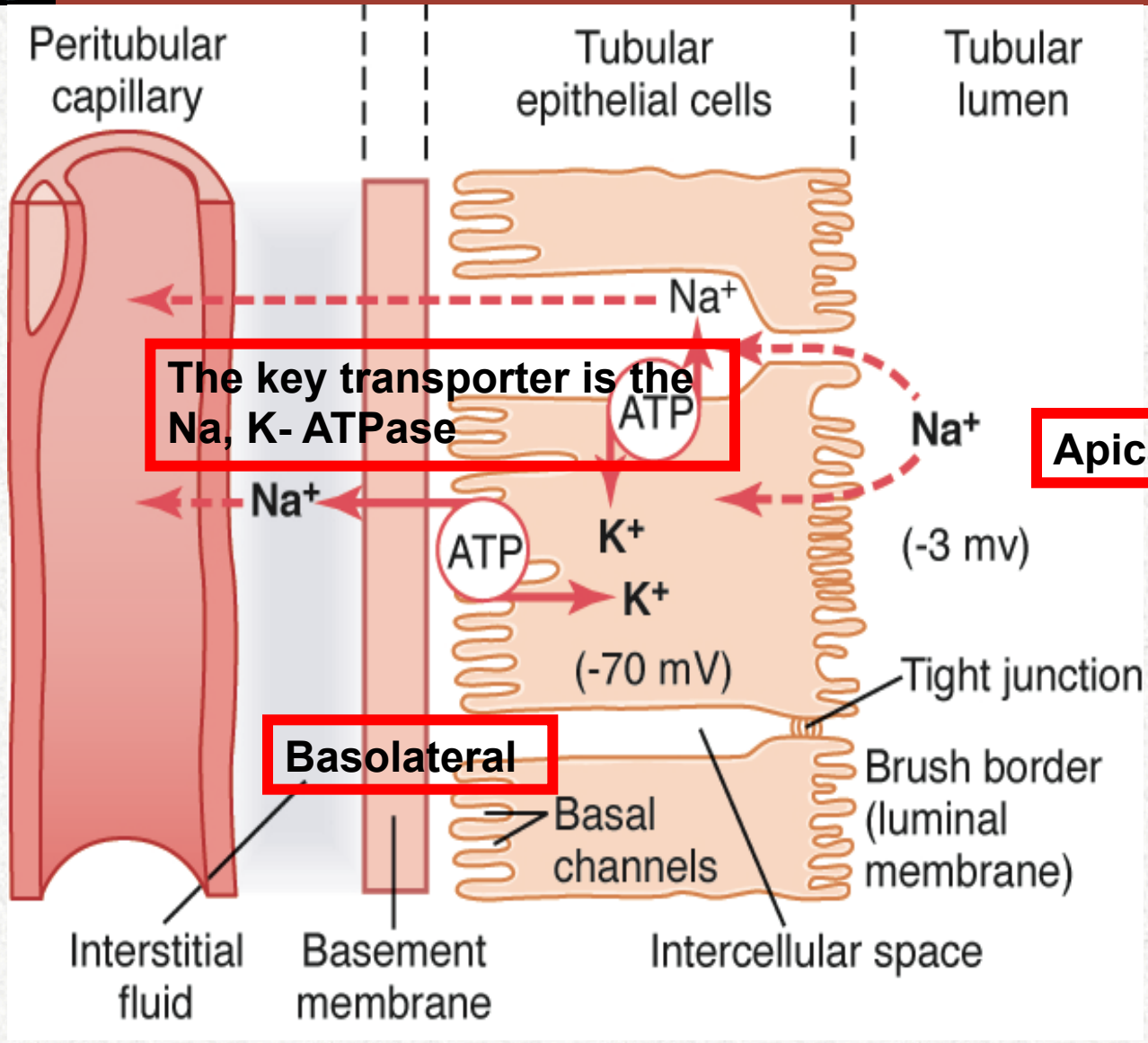

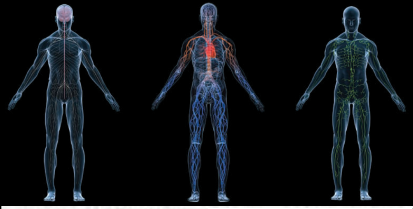

Proximal tubule reabsorption

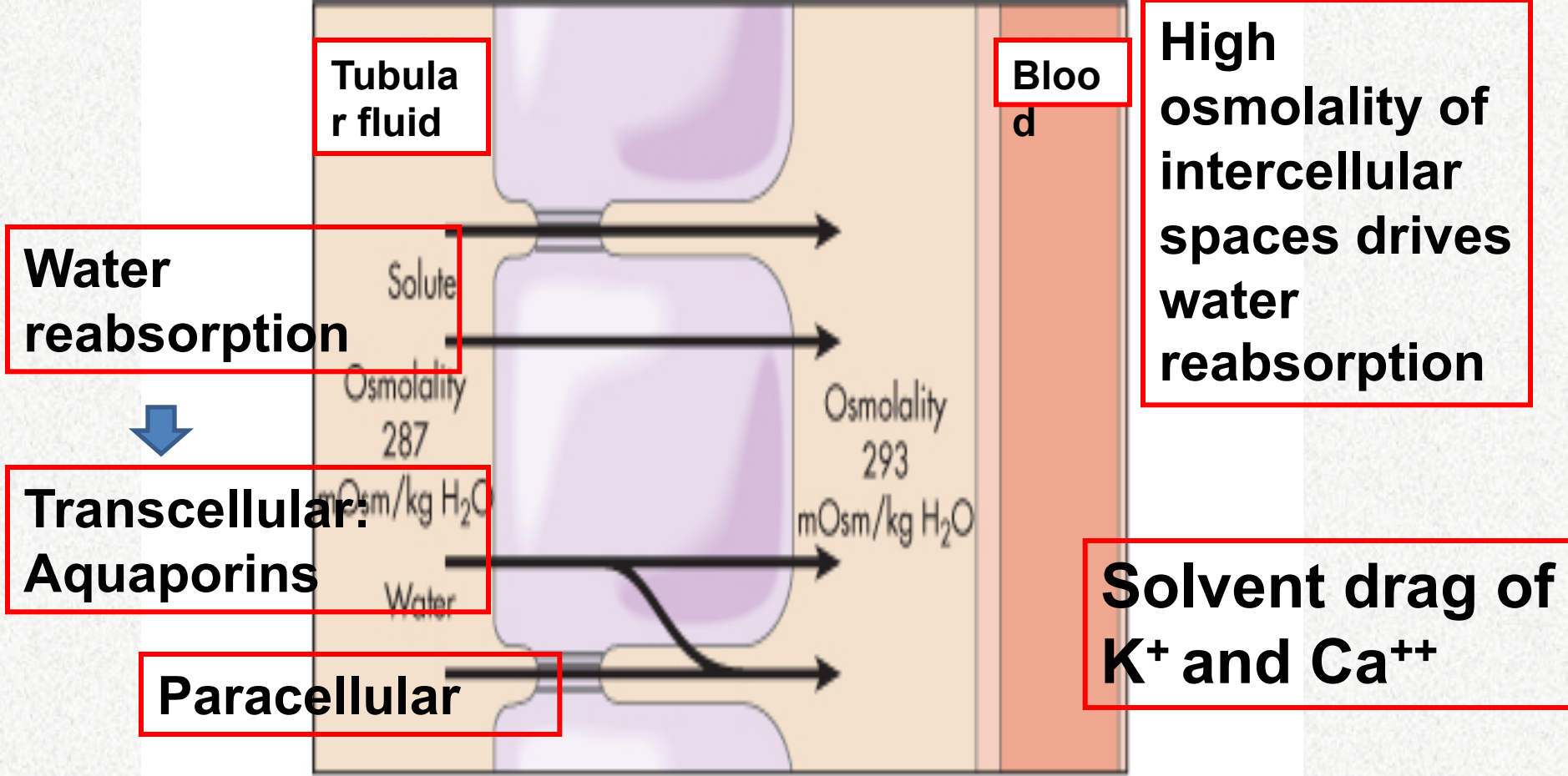

© Elsevier. Levy et al: Berne and Levy Principles of Physiology 4e - www.studentconsult.com

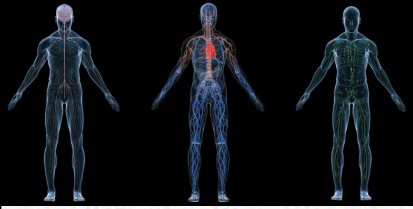

Glucose: Proximal Tubules

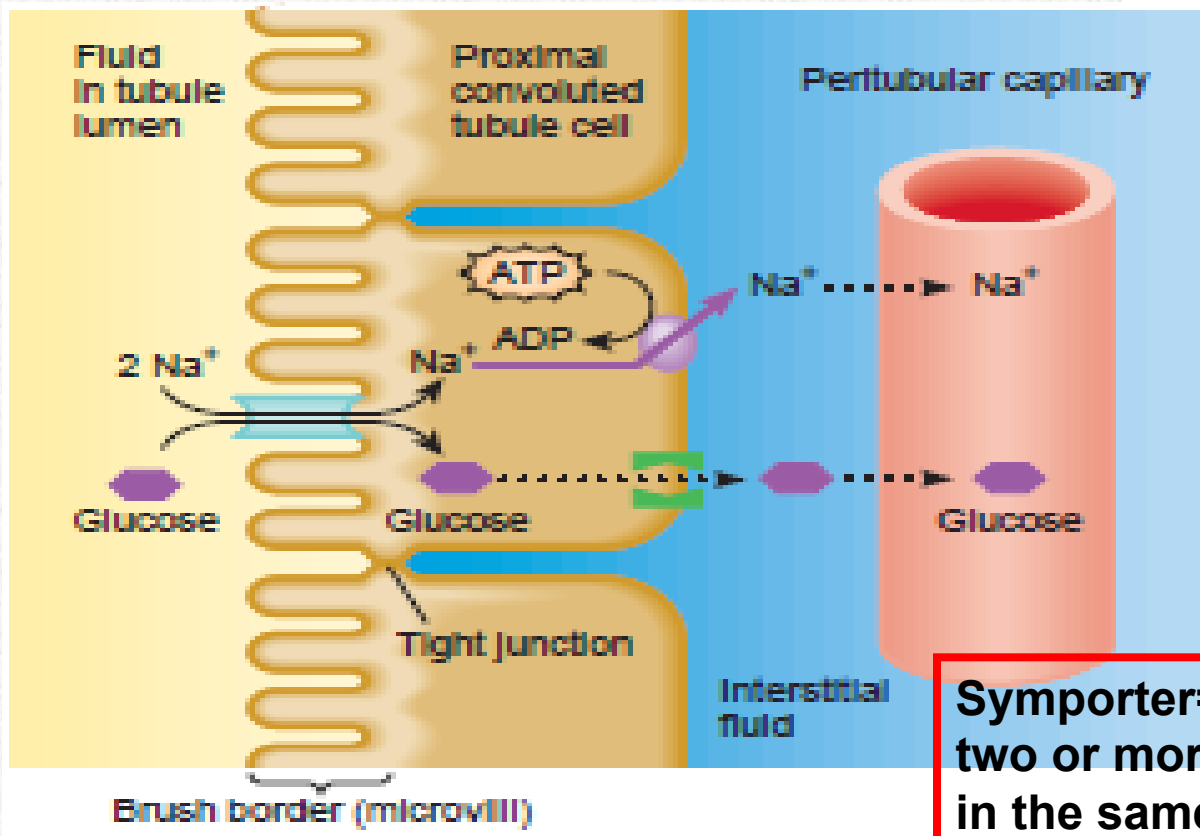
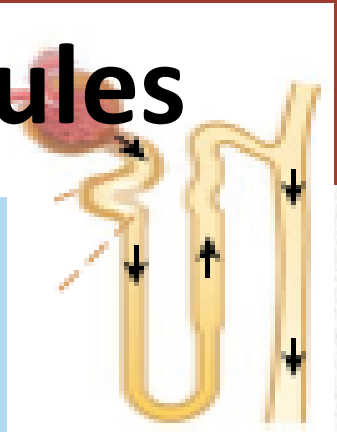

Symporter= transports two or more substances in the same direction

Glucose is transported via secondary active transport (facilitated diffusion)

- Key:**
- Na⁺-glucose symporter
 - Glucose facilitated diffusion transporter
 - Diffusion
 - Sodium-potassium pump

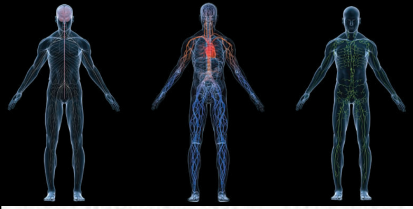

Mechanisms of secondary active transport.

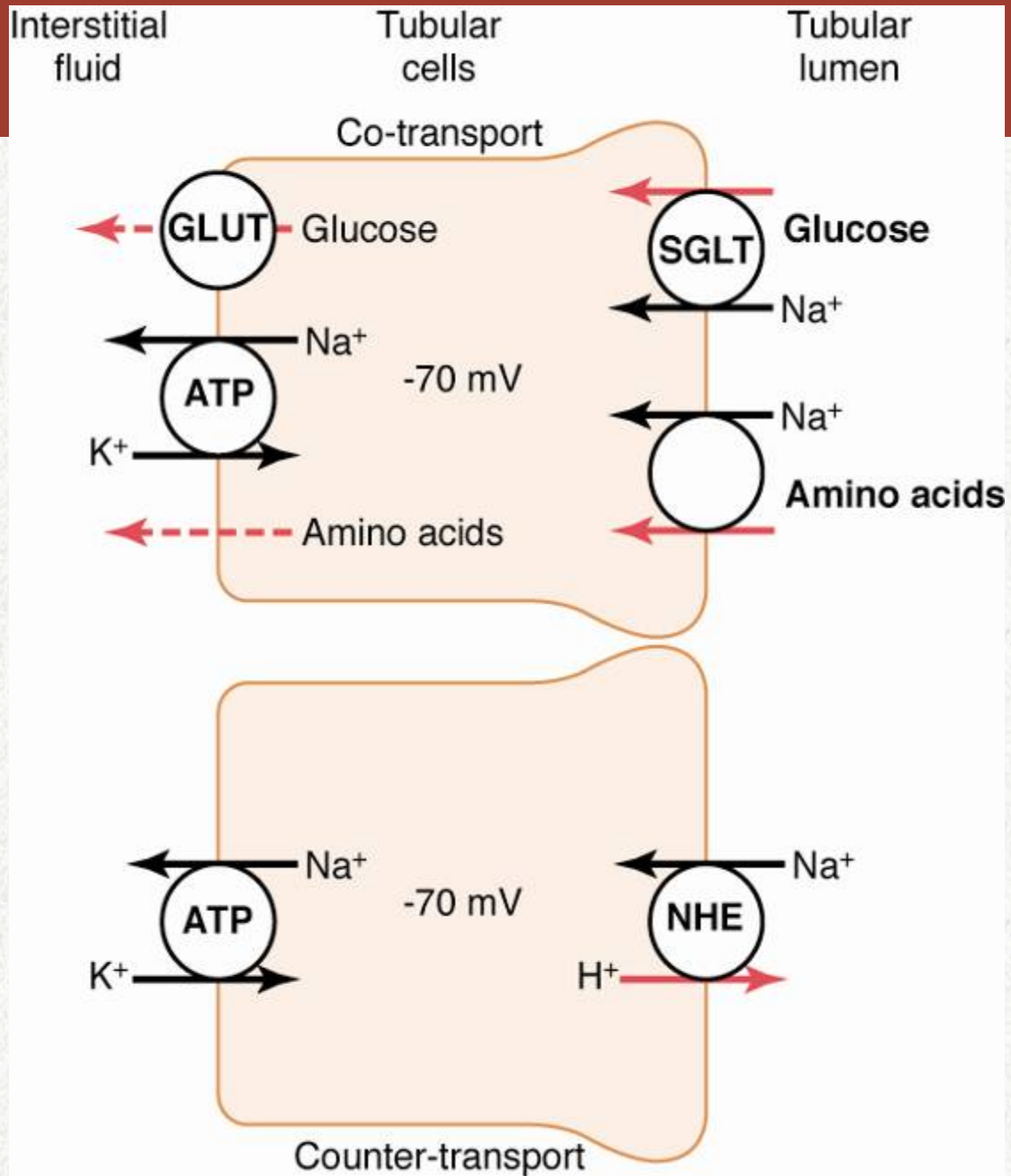
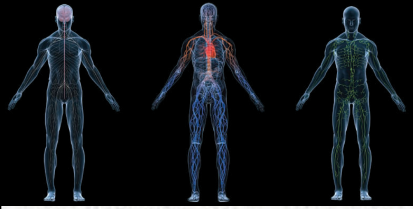

Figure 27-3



Glucose Transport Maximum

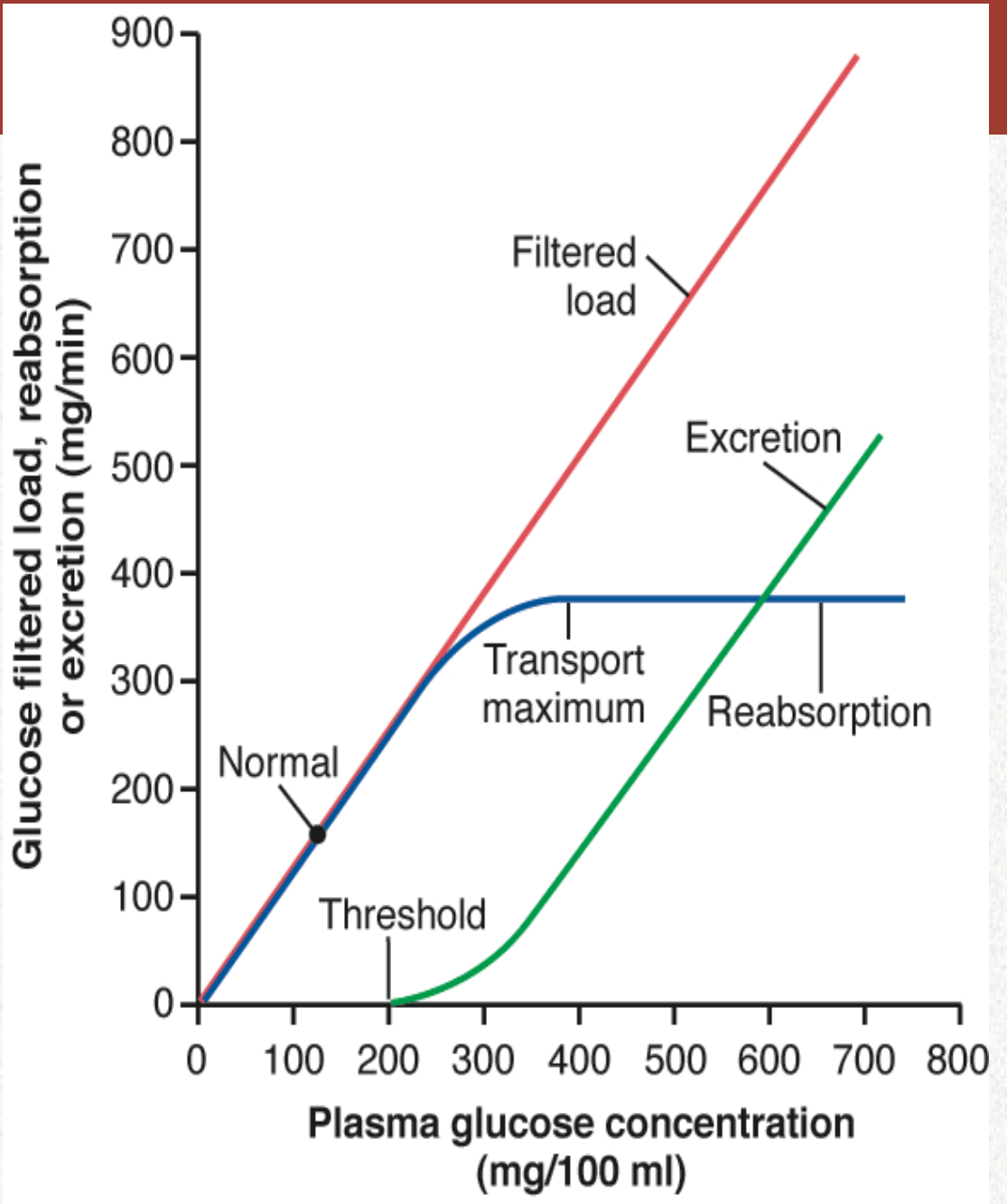
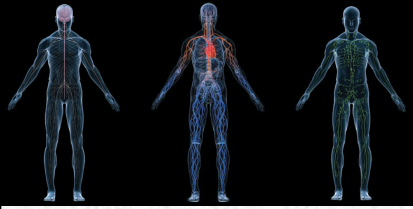
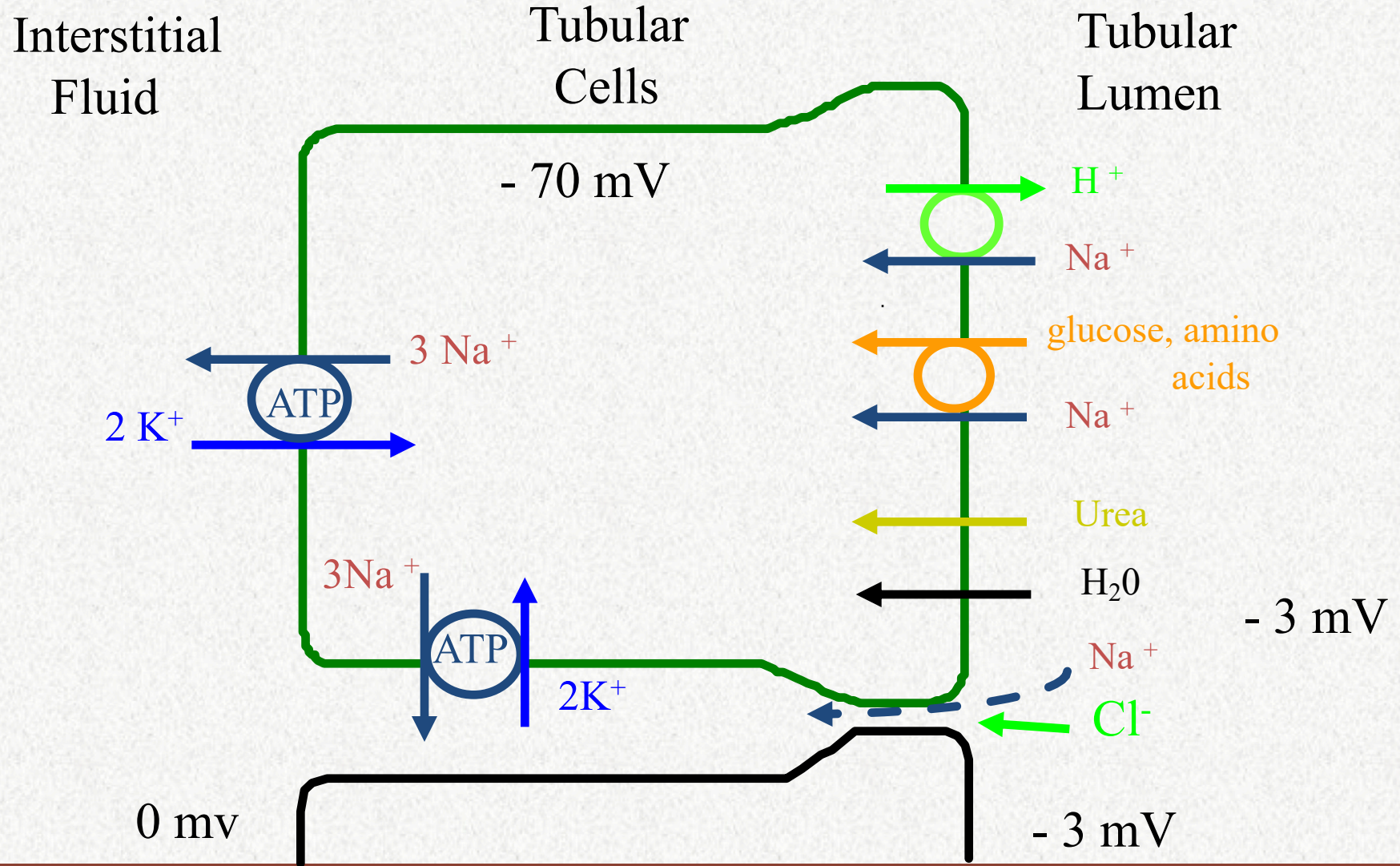
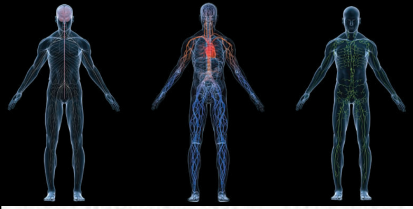

Figure 27-4



Reabsorption of Water and Solutes is Coupled to Na^+ Reabsorption





Mechanisms by which water, chloride, and urea reabsorption are coupled with sodium reabsorption

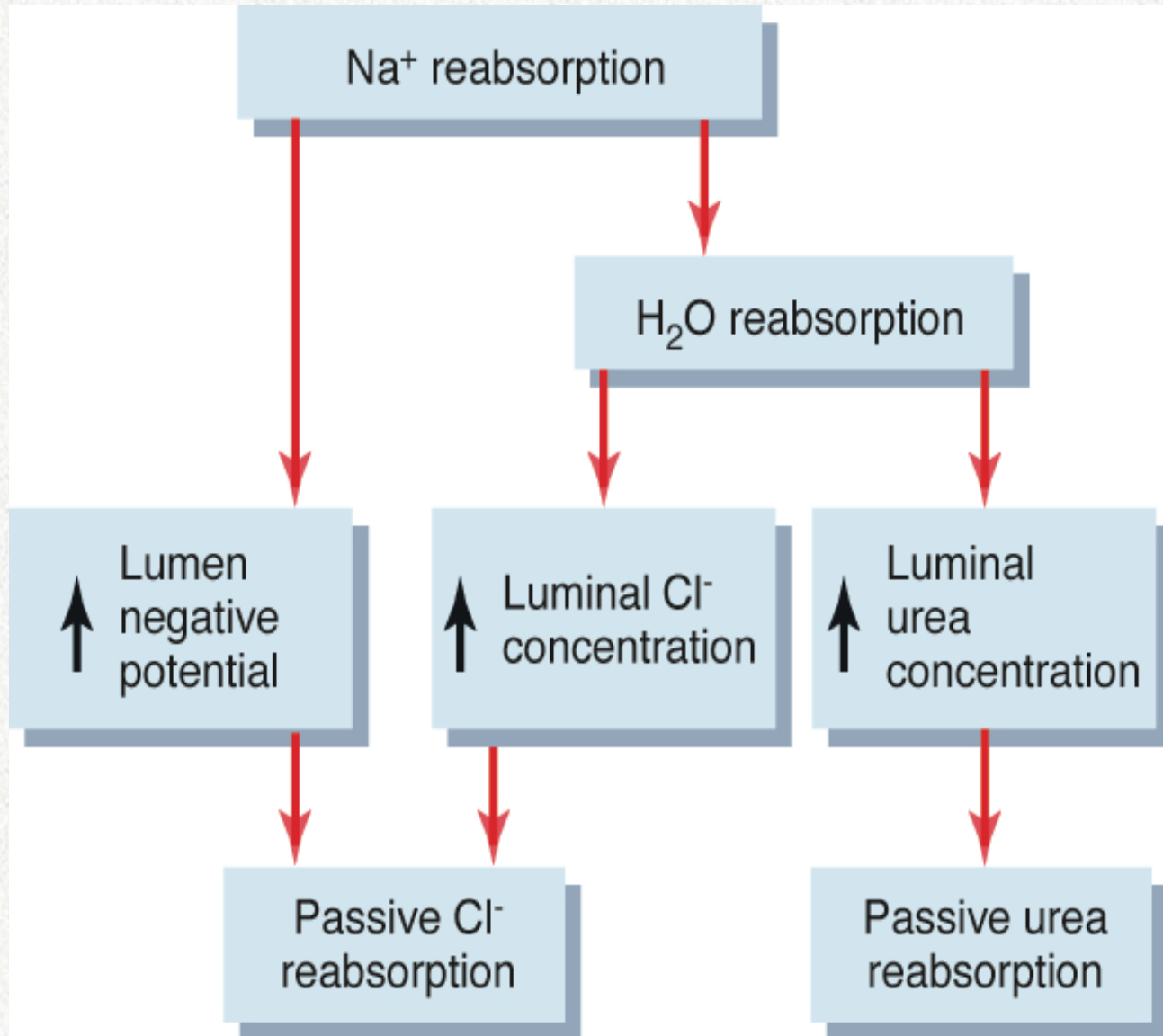
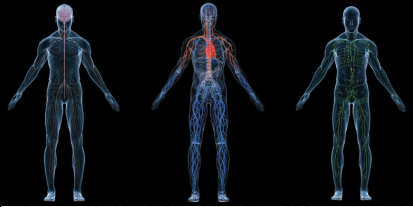
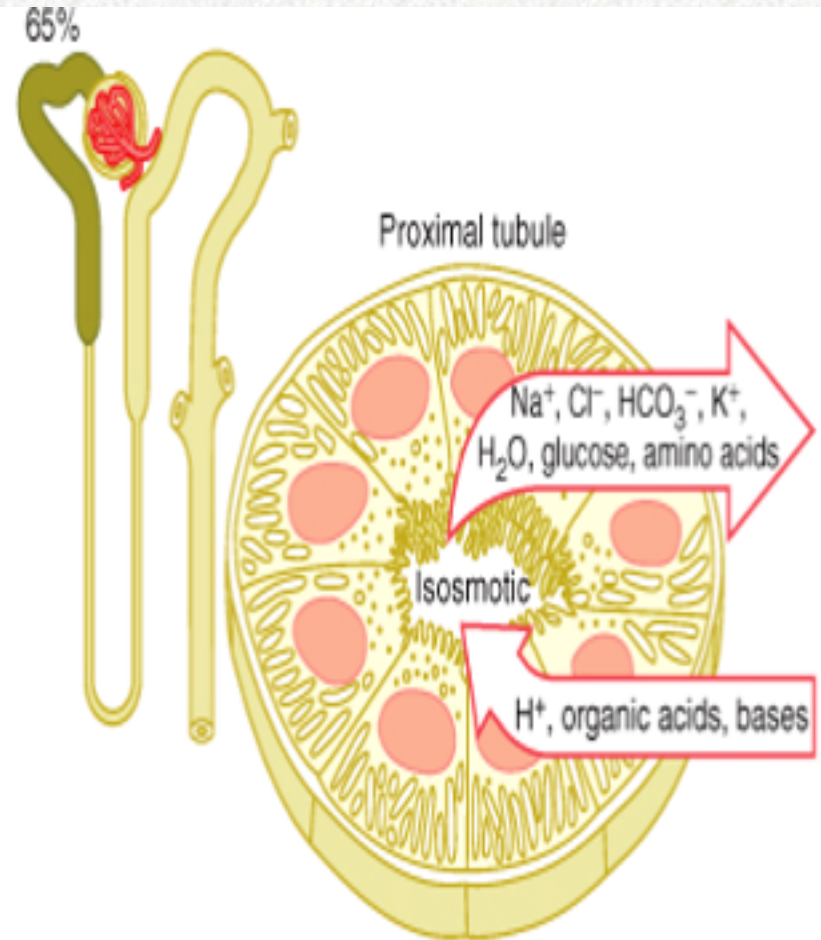

Figure 27-5



Proximal Tubules

- The proximal tubules reabsorbs about 67% of filtered water, Na^+ , Cl^- , K^+ , HCO_3^- .
- The proximal tubules reabsorbs almost all glucose and amino acids filtered by the glomeruli.
- The key transporter element is the Na, K- ATP ase in the basolateral membrane.



: Guyton & Hall: Textbook of Medical Physiology 11e - www.studentconsult.com.

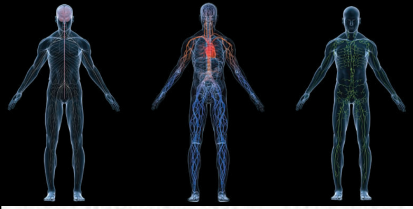

Changes in concentration in proximal tubule

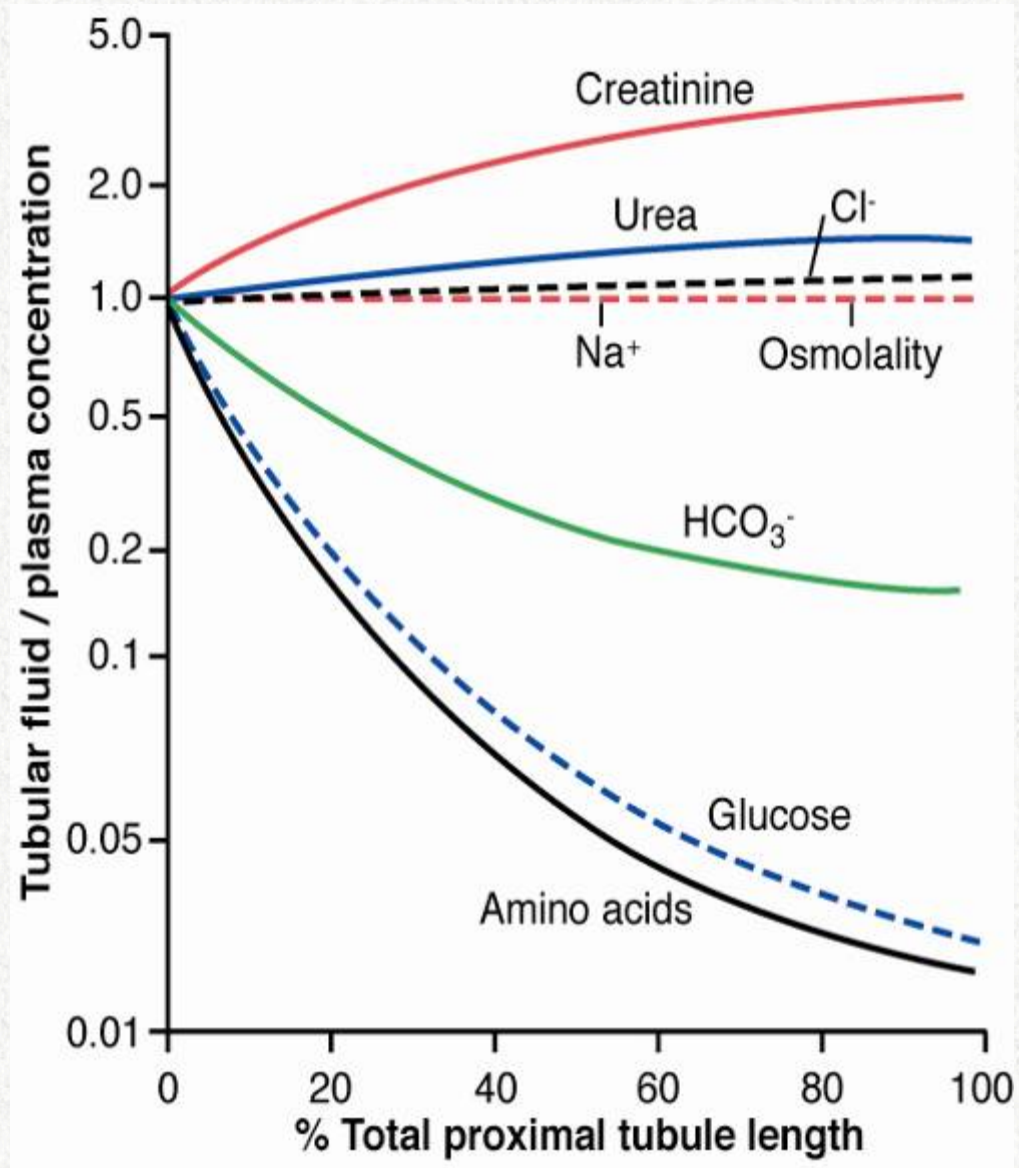
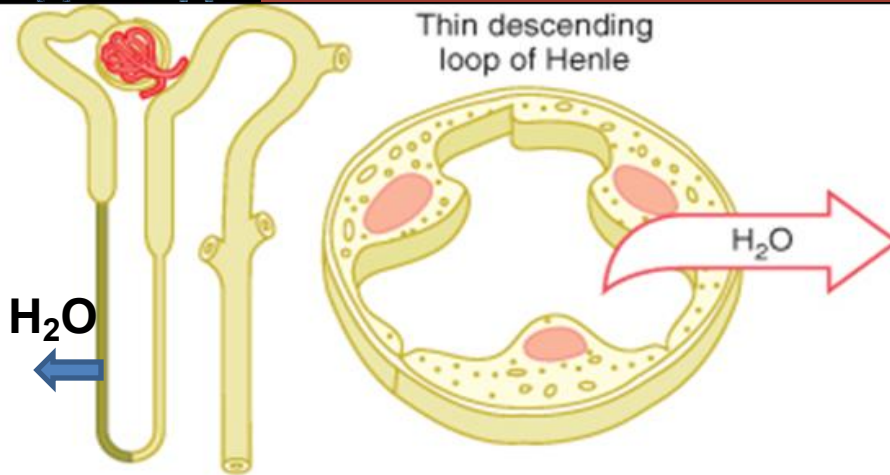

Figure 27-7



Loop of Henle



Thin descending loop of Henle

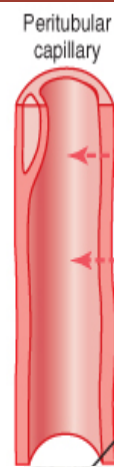

Thin Descending
□ 15% of H₂O reabsorbed.

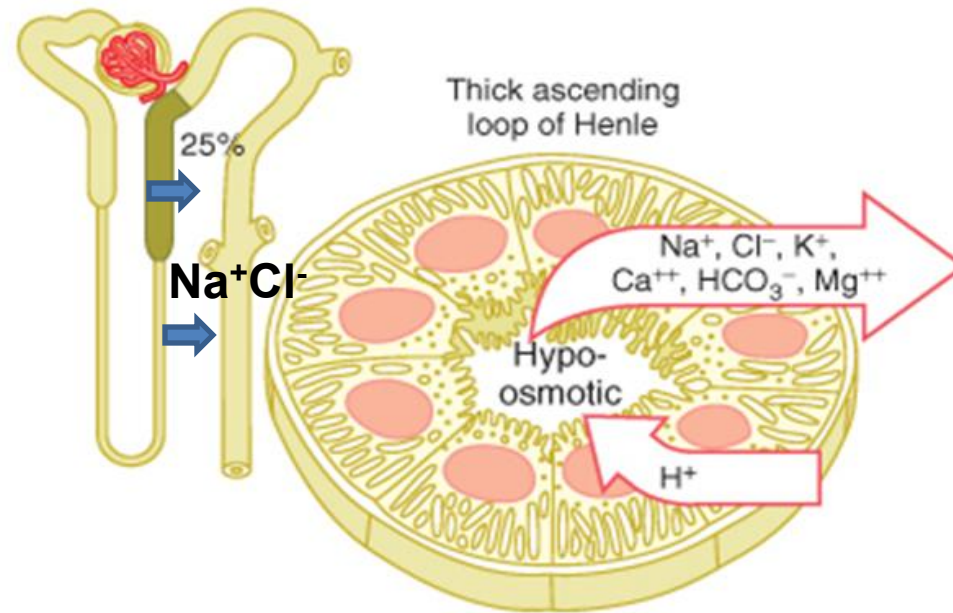

Thick ascending loop of Henle

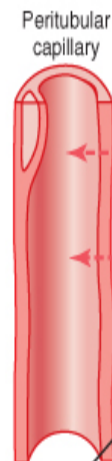

Thick Ascending
25% of Na⁺, K⁺, Cl⁻, HCO₃⁻, Ca⁺⁺, Mg⁺⁺ reabsorbed.
□ Impermeable to H₂O.
□ Called = Diluting segment.
□ Secretion of H⁺

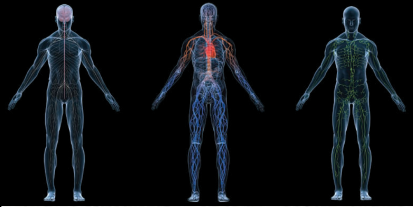

Loop of Henle

- Water reabsorption occurs exclusively in the **thin descending** limb of Henle via AQP1 water channels.(**Aquaporins**)
- Reabsorption of **NaCl** occurs in both thin and thick **ascending** limb of Henle.
- In thin ascending limb NaCl is reabsorbed passively. However, in thick ascending limb NaCl is reabsorbed through $\text{Na}^+\text{-K}^+$ ATPase in basolateral membrane ans .
- Ascending limb is impermeable to water.
- Reabsorption of Ca^{++} and HCO_3^- occurs also in Loop of Henle.

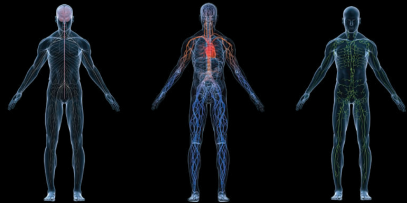

Thick ascending limb of Henle

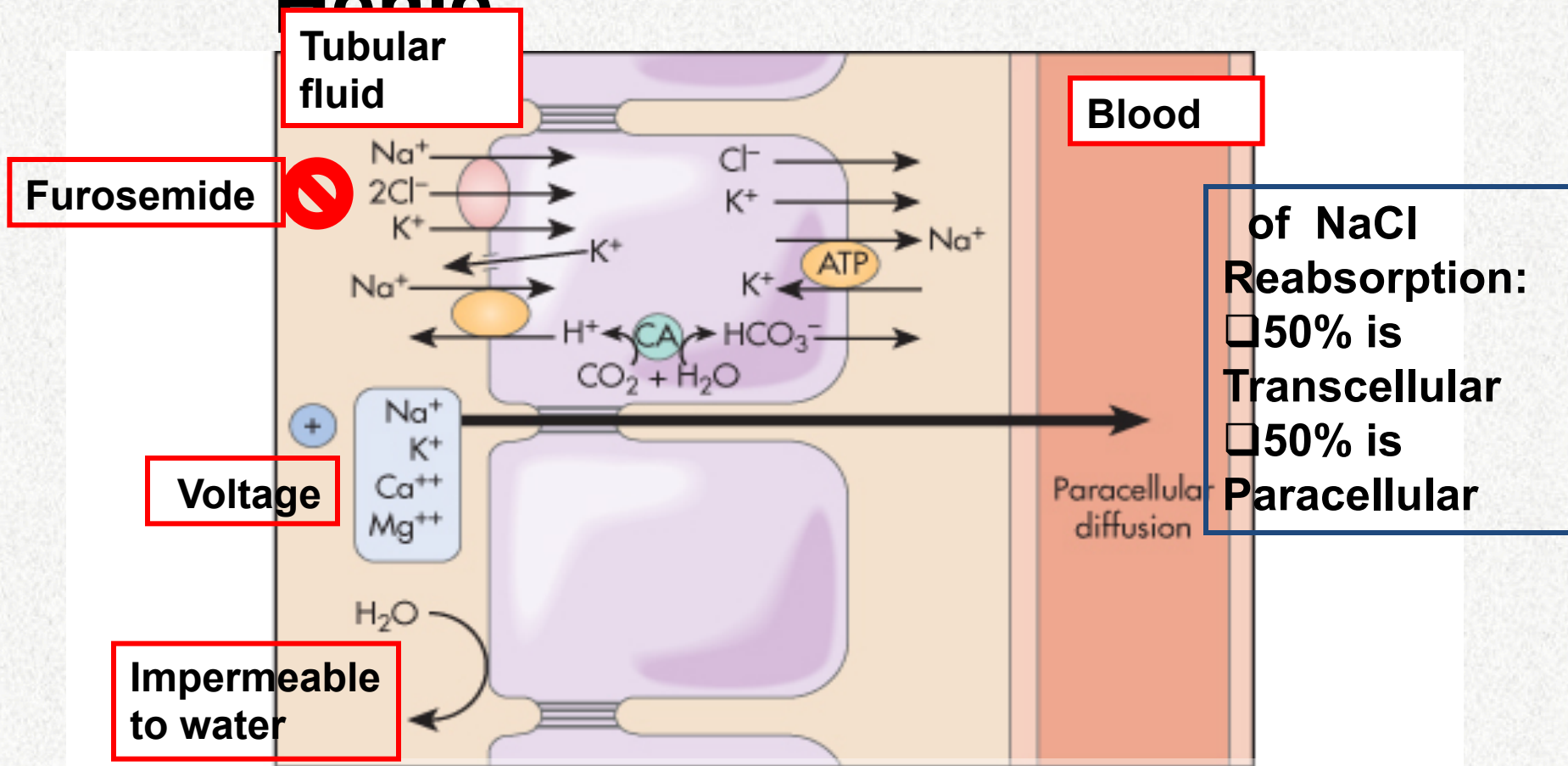

© Elsevier. Levy et al: Berne and Levy Principles of Physiology 4e - www.studentconsult.com

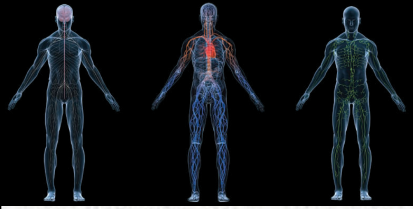

Sodium chloride and potassium transport in thick ascending loop of Henle

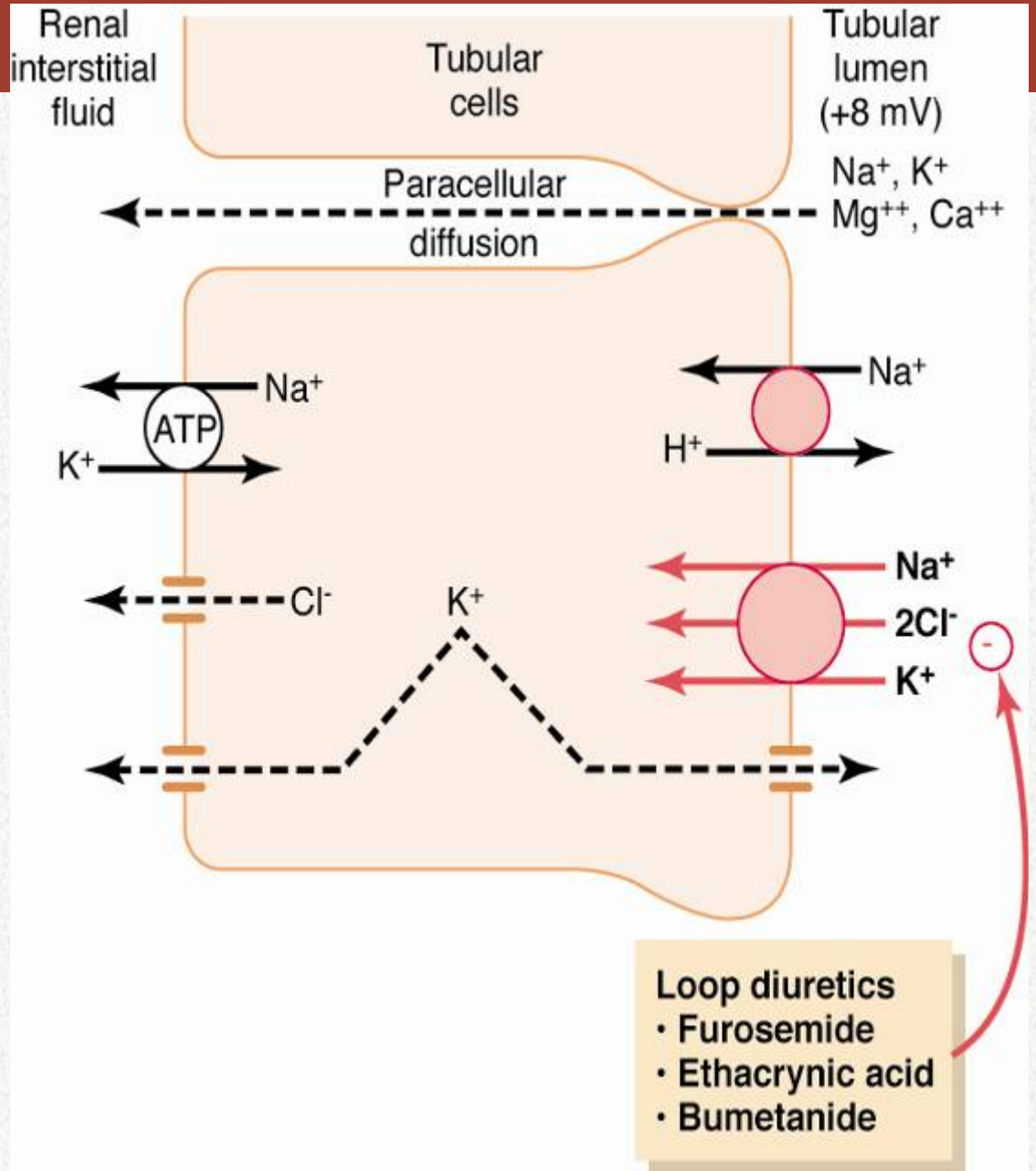
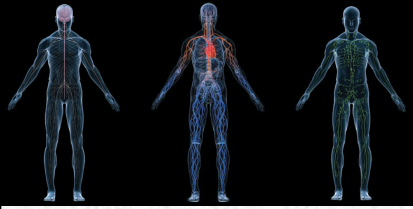

Figure 27-9



Early Distal Tubule

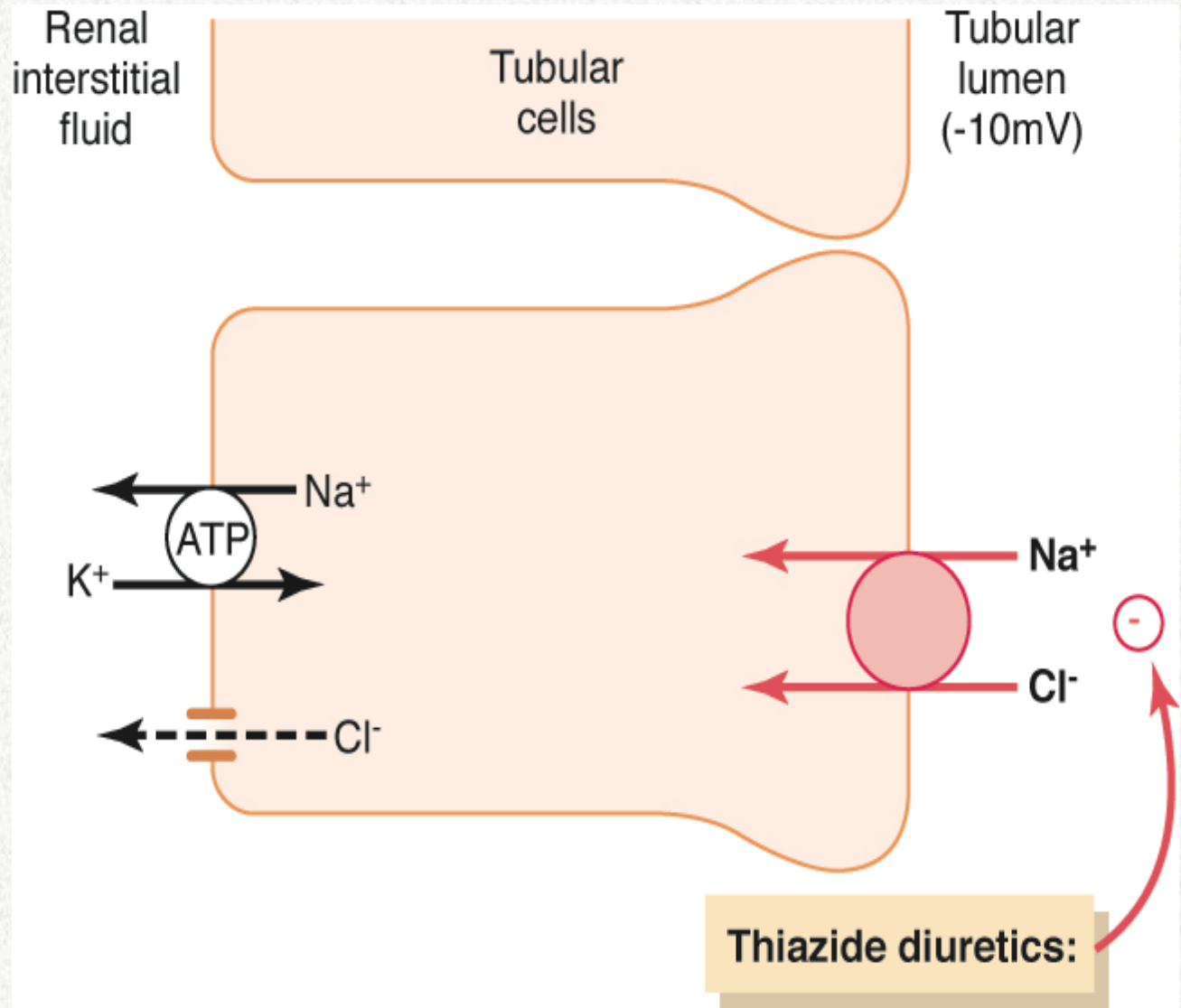
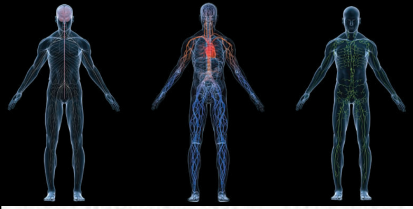
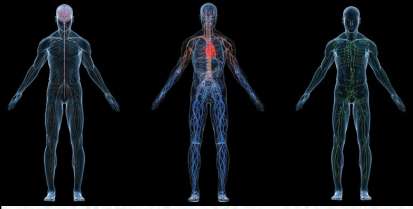

Figure 27-10



Early Distal Tubule

- Functionally similar to thick ascending loop
- Not permeable to water (called diluting segment)
- Active reabsorption of Na^+ , Cl^- , K^+ , Mg^{++}
- Contains macula densa



Distal tubule and collecting duct

- Reabsorbs 7% NaCl, secretes K^+ and H^+ and reabsorbs 8-17% H_2O

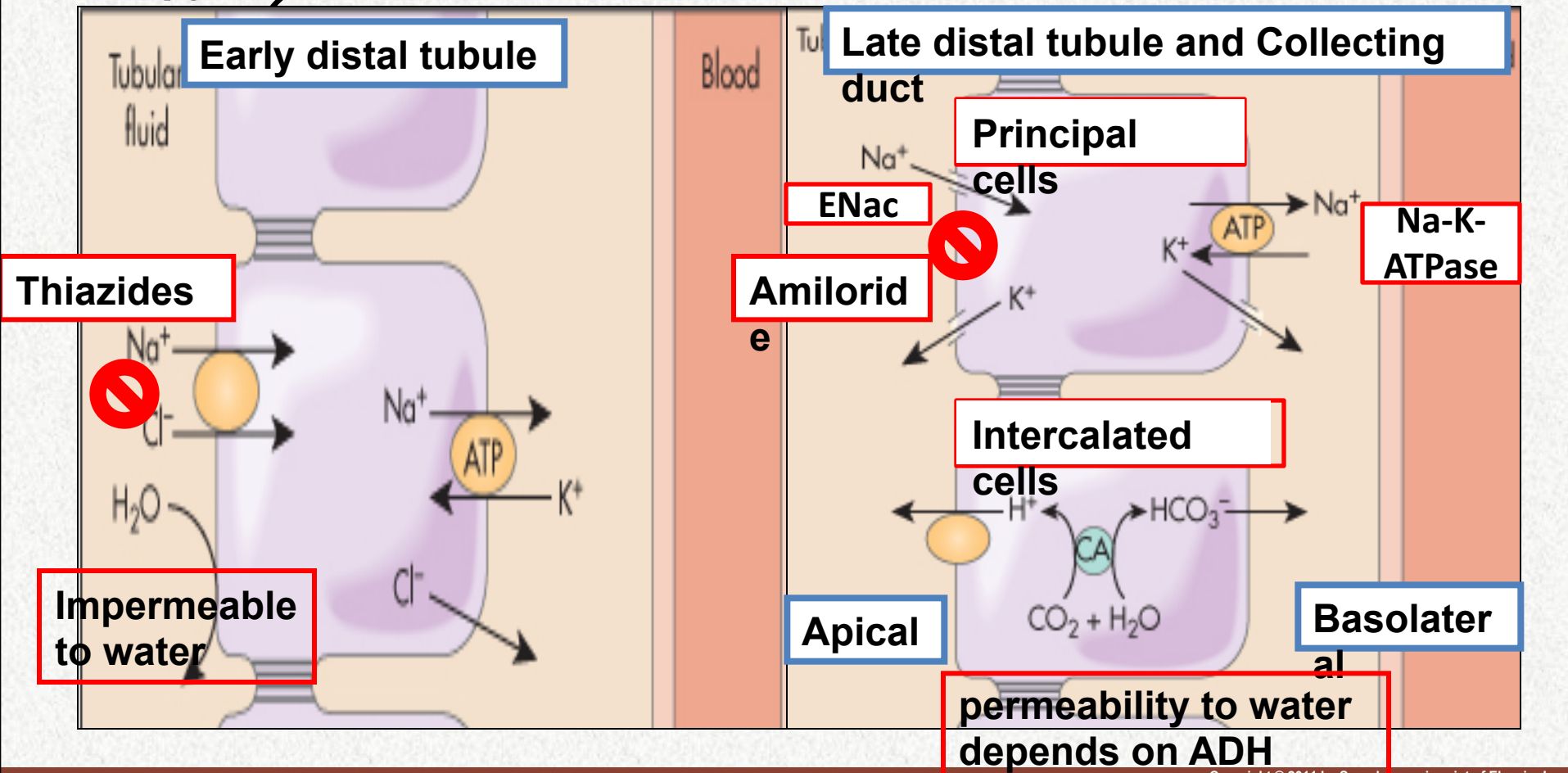

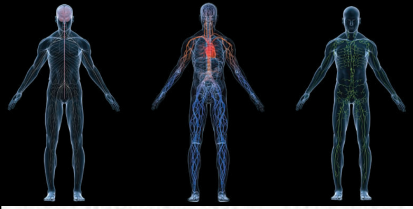

Early and Late Distal Tubules and Collecting Tubules.

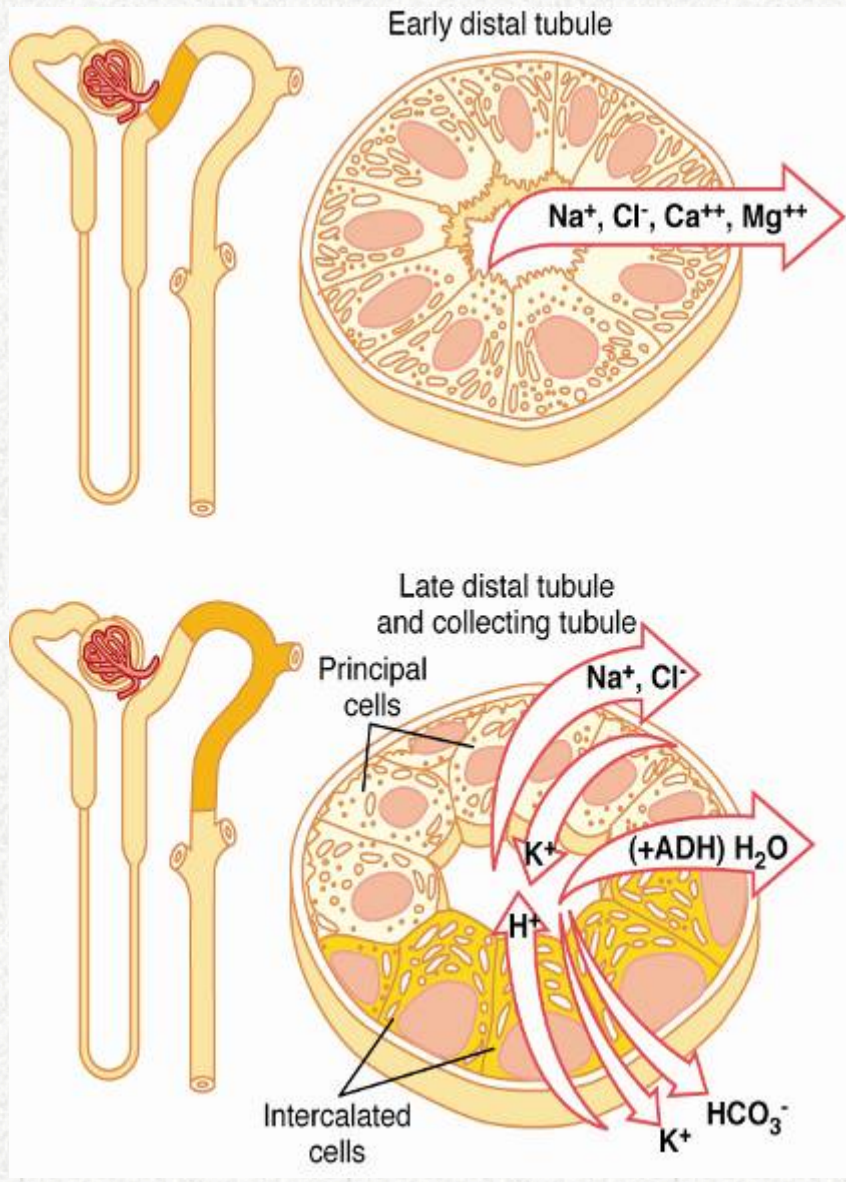

- ~ 5% of filtered load NaCl reabsorbed
- not permeable to H_2O
- not very permeable to urea

- permeability to H_2O depends on ADH
- not very permeable to urea

Figure 27-11

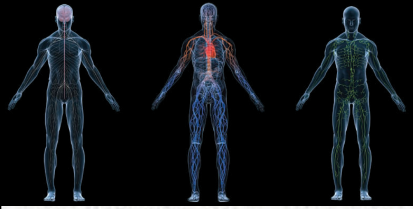

Late Distal and Cortical Collecting Tubules Principal Cells – Secrete K^+

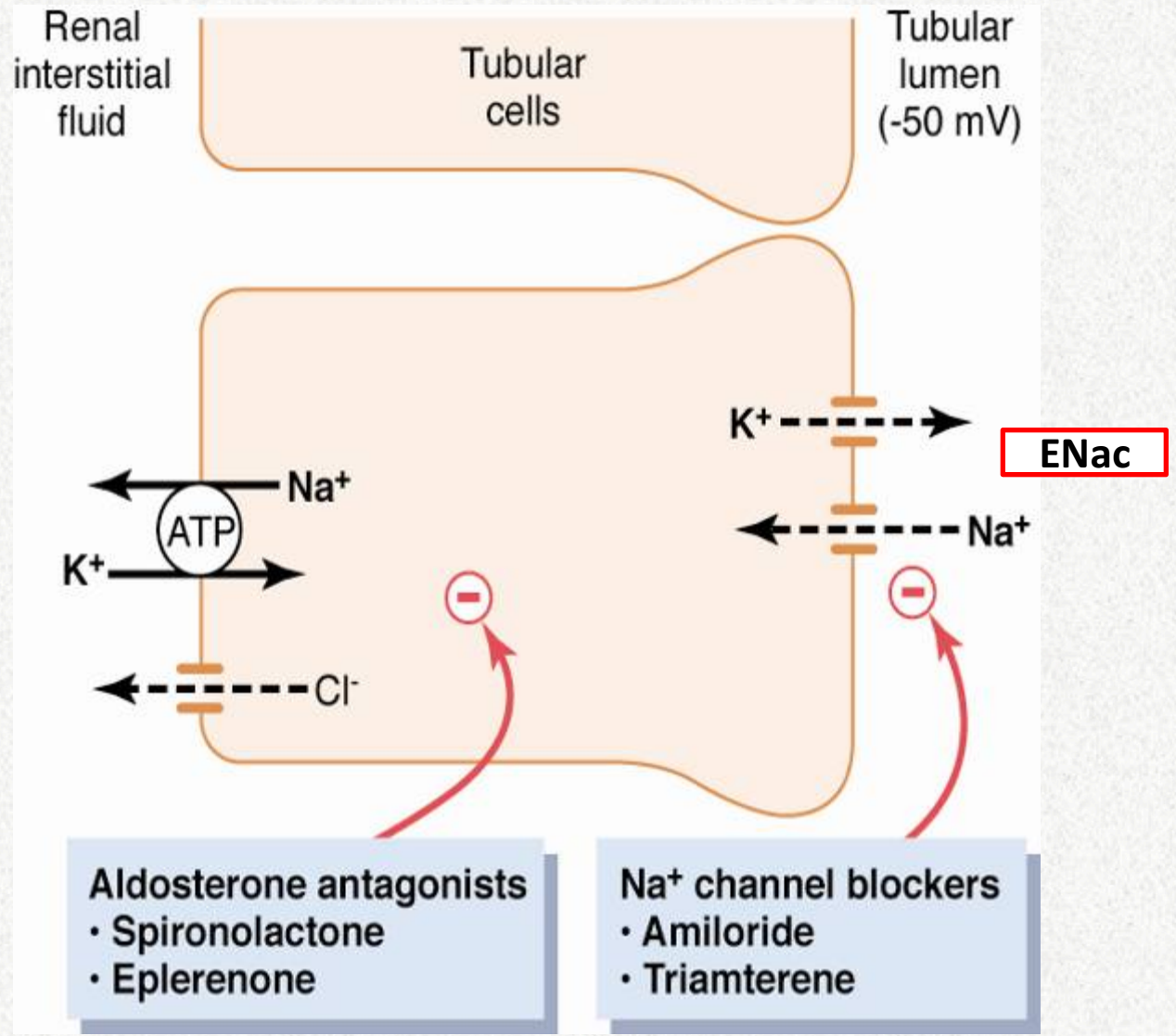
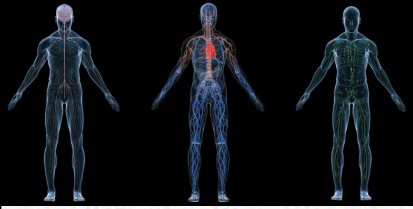
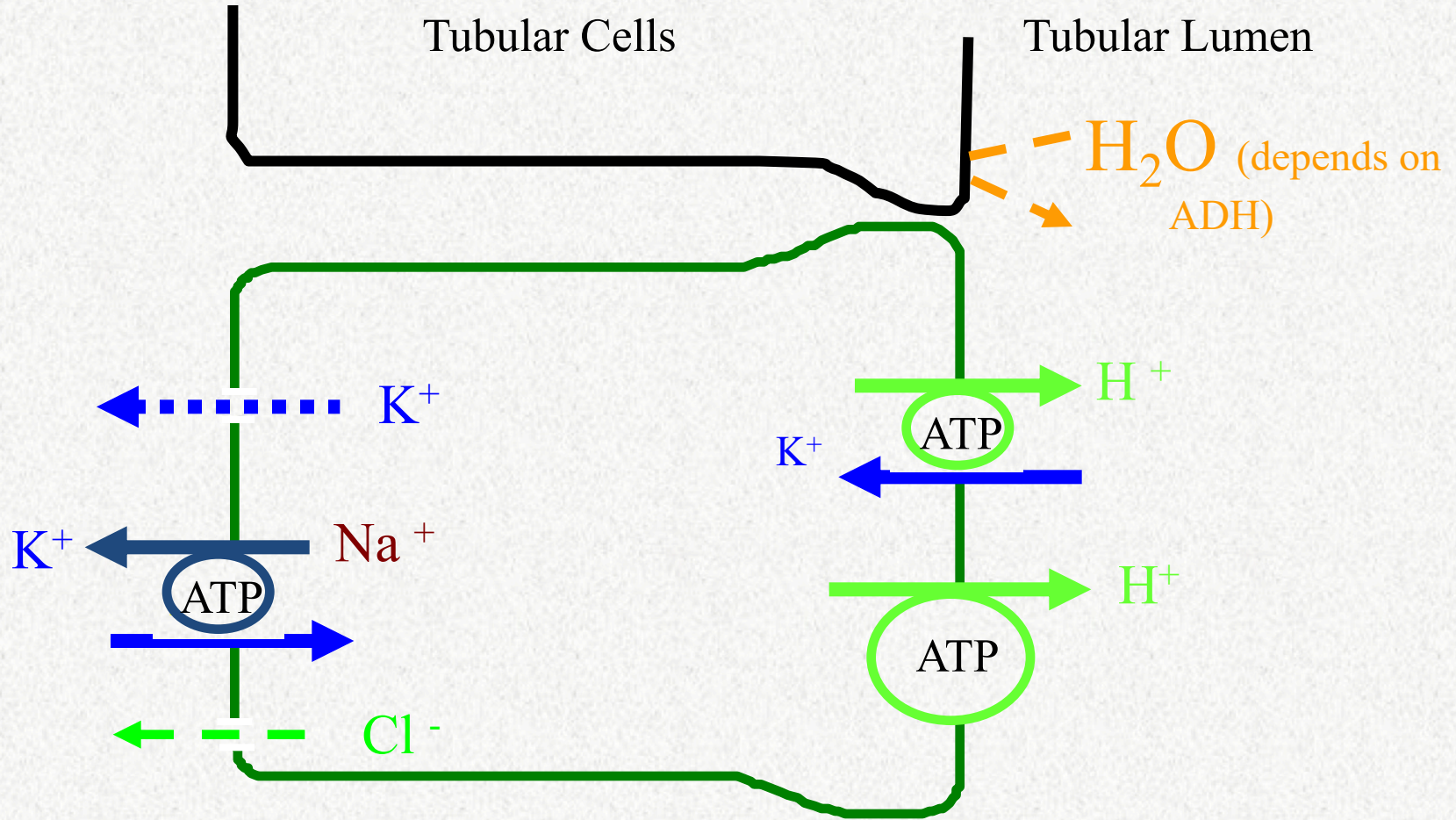

Figure 27-12



Late Distal and Cortical Collecting Tubules Intercalated Cells – Secrete H^+



Transport characteristics of medullary collecting ducts

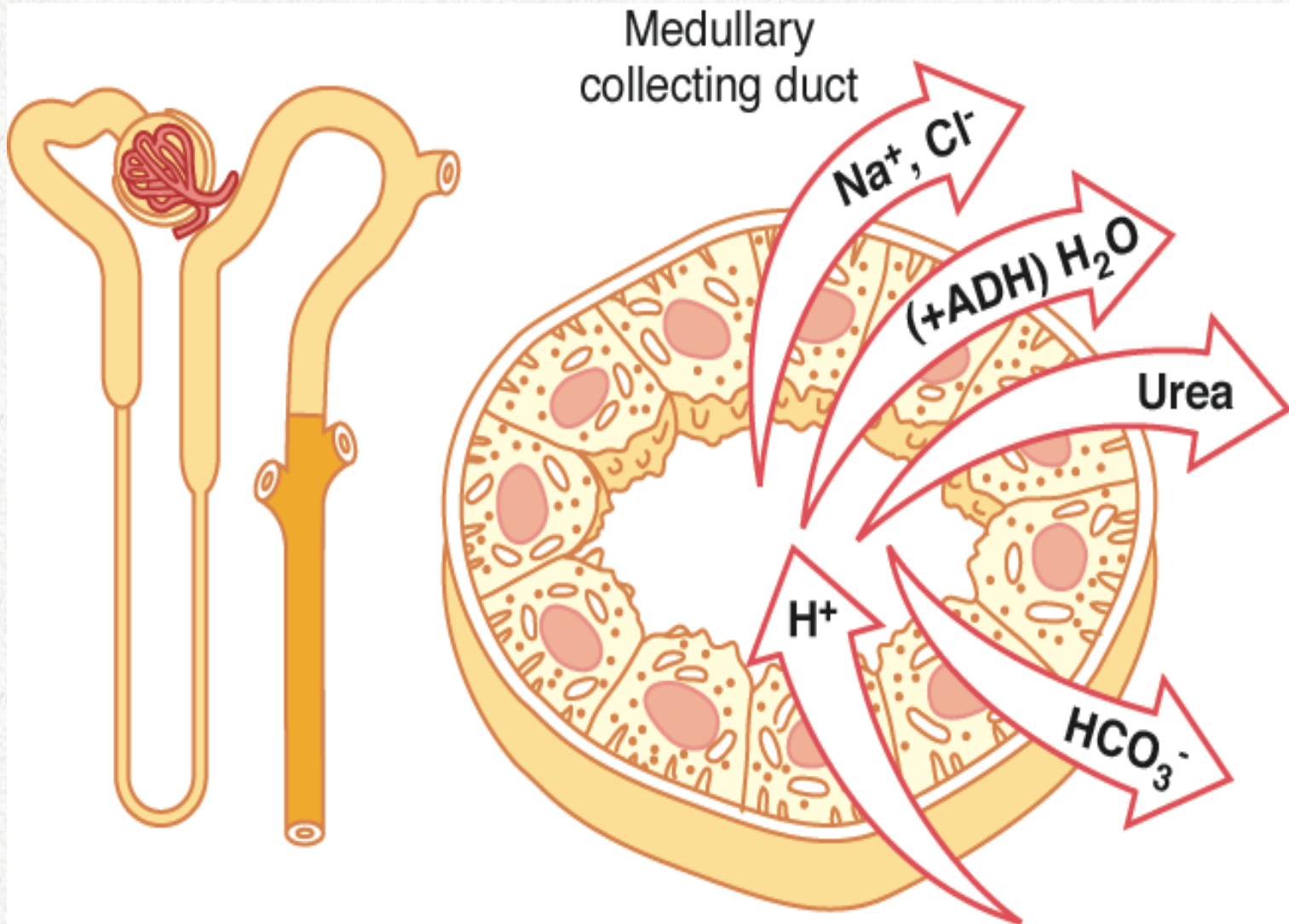
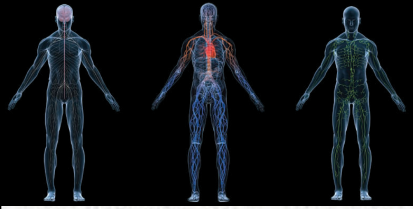
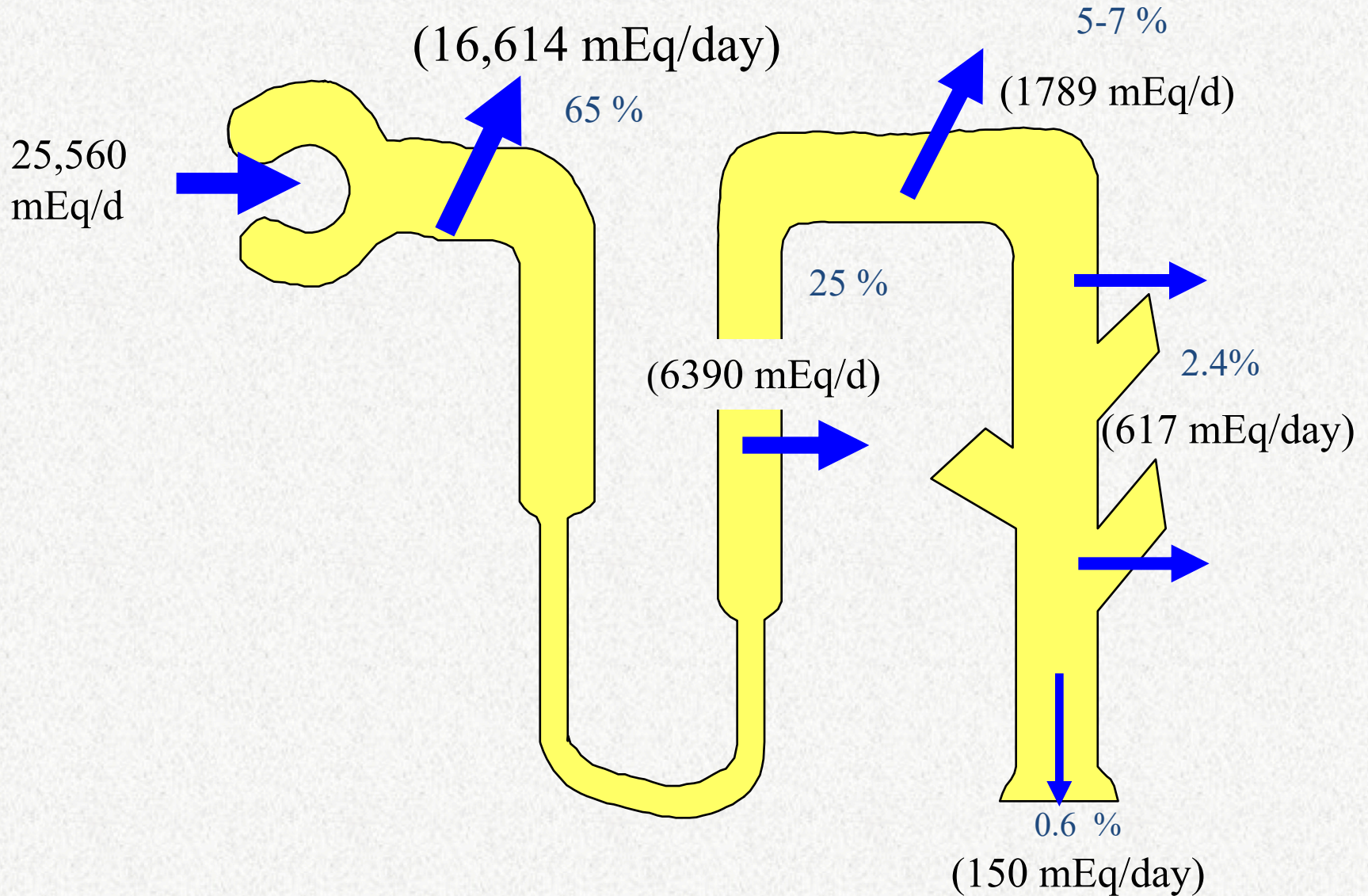
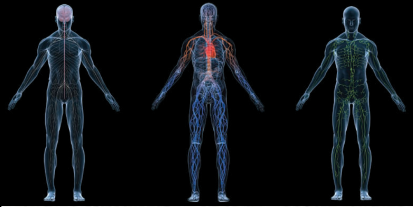

Figure 27-13



Normal Renal Tubular Na^+ Reabsorption





Concentrations of solutes in different parts of the tubule depend on relative reabsorption of the solutes compared to water

- If water is reabsorbed to a greater extent than the solute, the solute will become more concentrated in the tubule (e.g. creatinine, inulin)
- If water is reabsorbed to a lesser extent than the solute, the solute will become less concentrated in the tubule (e.g. glucose, amino acids)

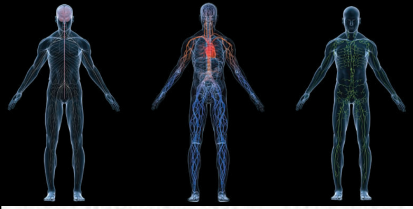

Changes in concentrations of substances in the renal tubules

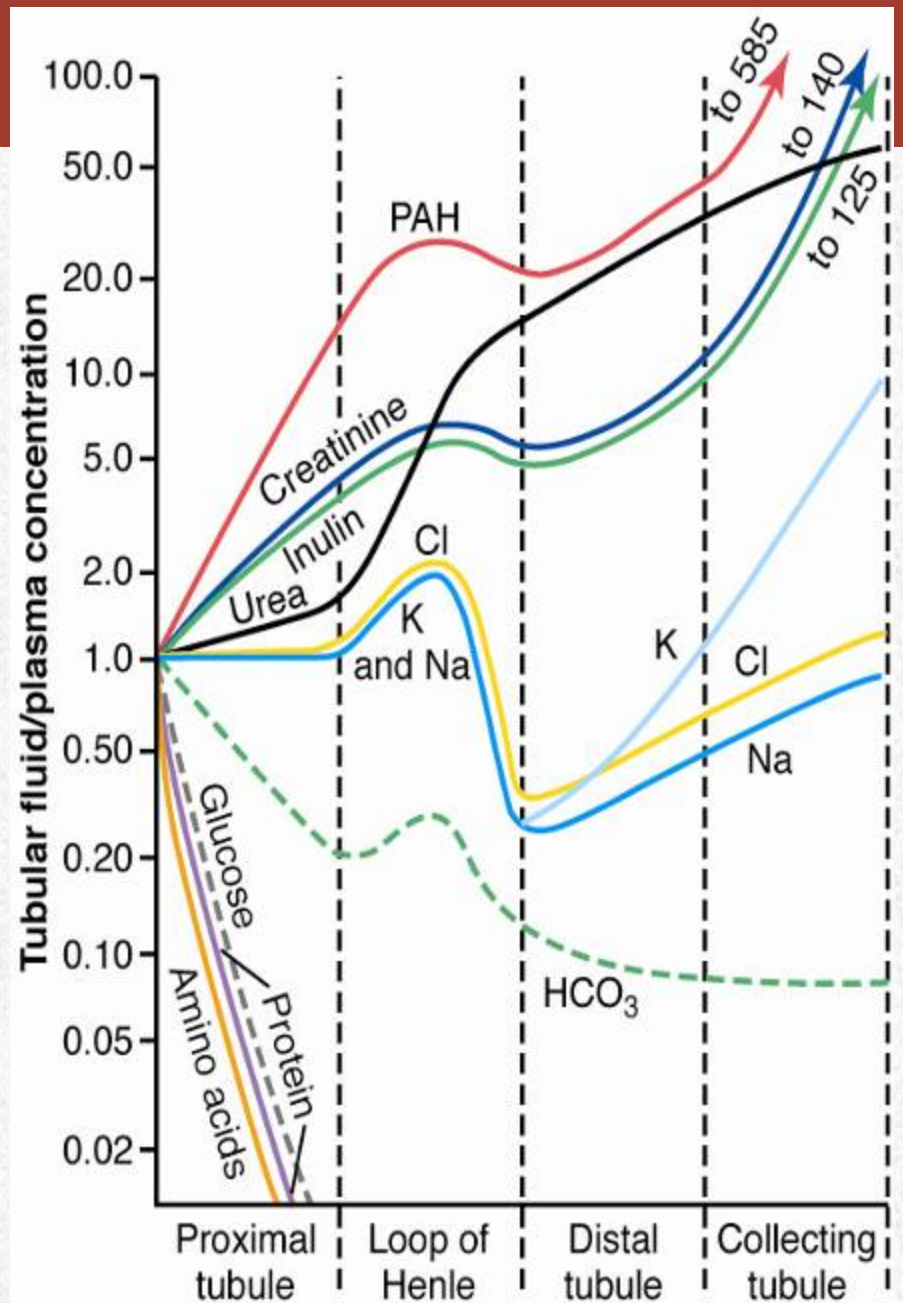
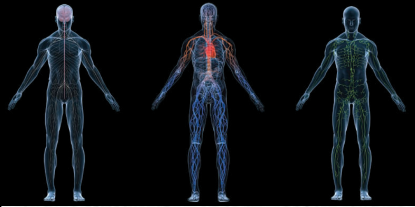

Figure 27-14



The figure below shows the concentrations of inulin at different points along the tubule, expressed as the tubular fluid/plasma (TF/P_{inulin}) concentration of inulin. If inulin is not reabsorbed by the tubule, what is the percentage of the filtered water that has been reabsorbed or remains at each point? What percentage of the filtered water has been reabsorbed up to that point?

A = $1/3$ (33.33 %) remains
66.67 % reabsorbed

B = $1/8$ (12.5 %) remains
87.5 % reabsorbed

C = $1/50$ (2.0 %) remains
98.0 % reabsorbed

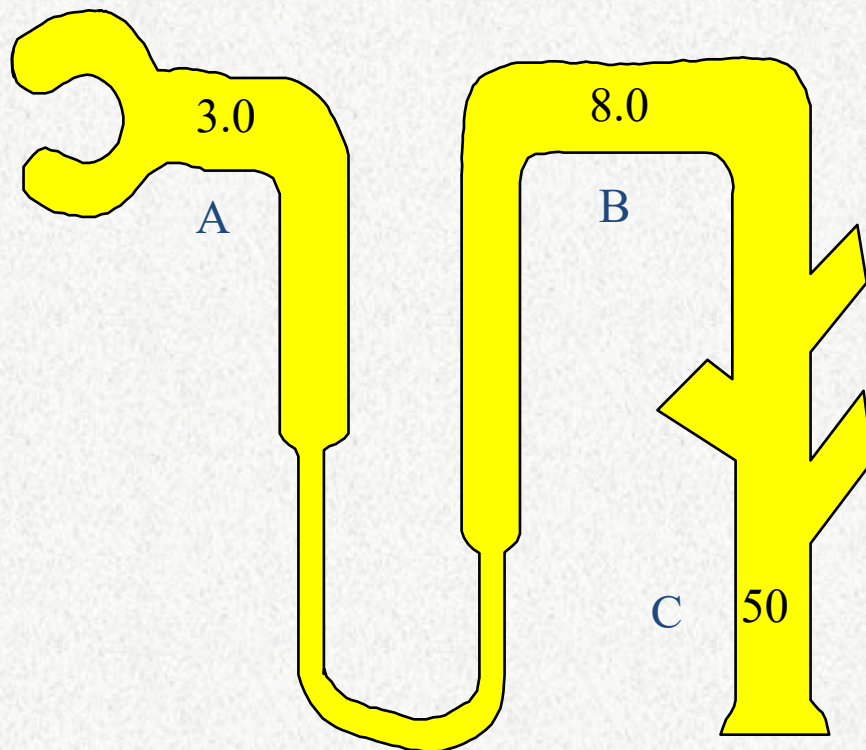

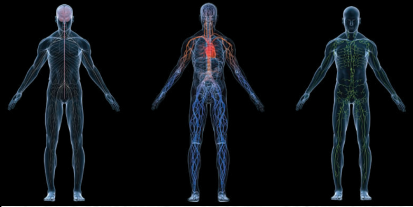

Regulation of Tubular Reabsorption

- Glomerulotubular Balance
- Peritubular Physical Forces
- Hormones
 - aldosterone
 - angiotensin II
 - antidiuretic hormone (ADH)
 - natriuretic hormones (ANF)
 - parathyroid hormone
- Sympathetic Nervous System
- Arterial Pressure (pressure natriuresis)
- Osmotic factors

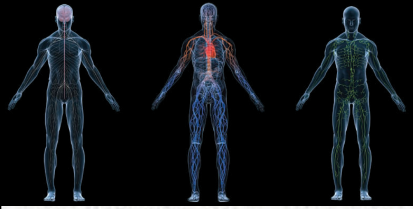

Glomerulotubular Balance

Tubular
Reabsorption

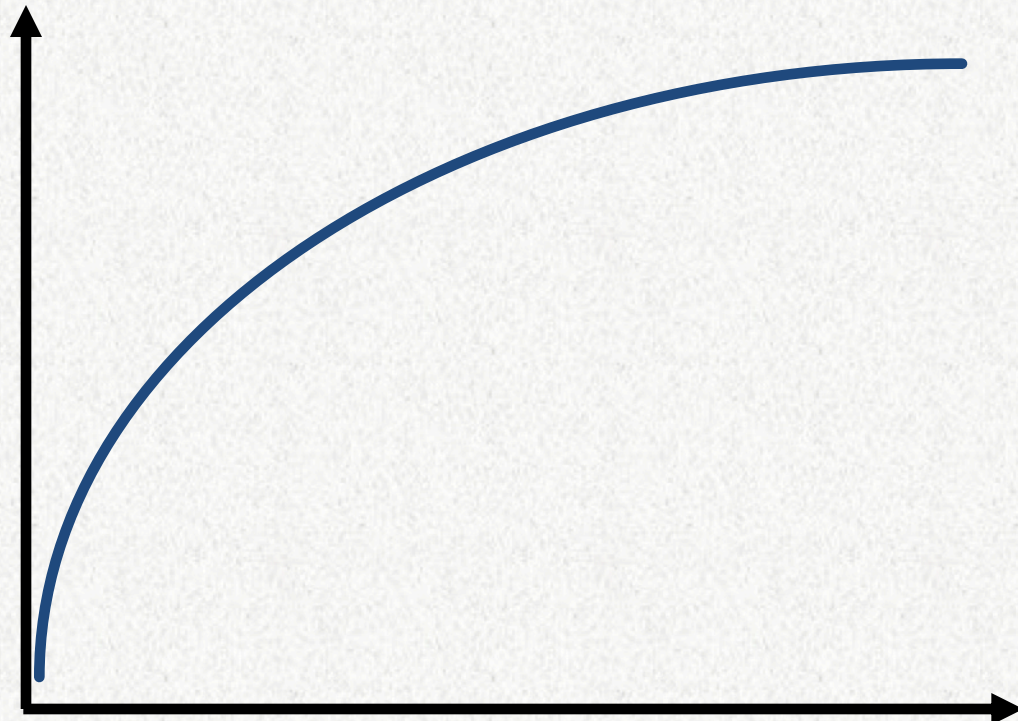

Tubular Load

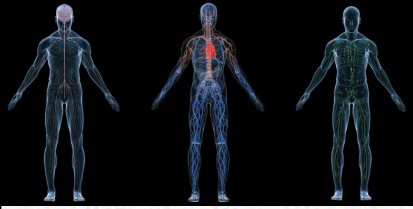

Importance of Glomerulotubular Balance in Minimizing Changes in Urine Volume

GFR	Reabsorption	Urine Volume	% Reabsorption
-----	--------------	--------------	----------------

no glomerulotubular balance

125	124	1.0	99.2
150	124	26.0	82.7

“perfect” glomerulotubular balance

150	148.8	1.2	99.2
-----	-------	-----	------

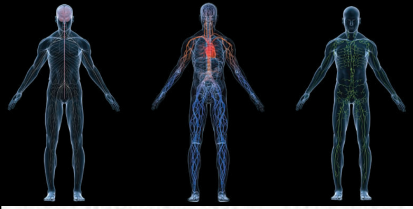

Peritubular capillary reabsorption

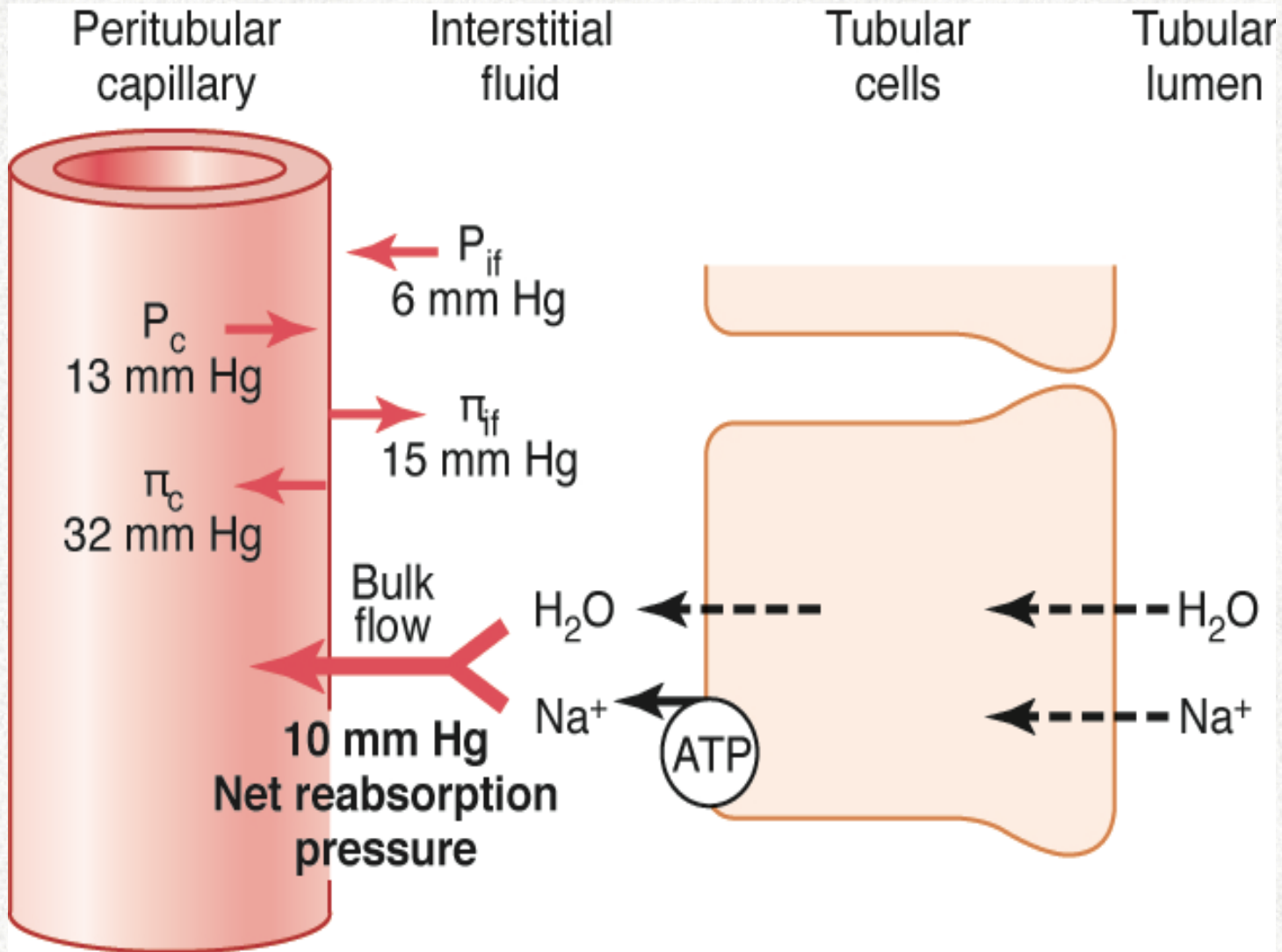
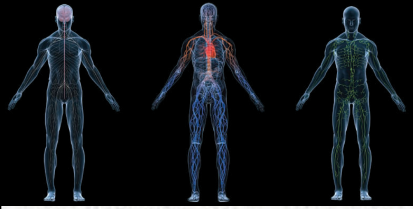

Figure 27-15



Calculation of Tubular Reabsorption

(when $\text{Excret } s < \text{Filt } s$)

$$\text{Reabsorption} = \text{Filtration} - \text{Excretion}$$

$$\text{Filt } s = \text{GFR} \times P_s$$

(P_s = Plasma conc of s)

$$\text{Excret } s = U_s \times V$$

U_s = Urine conc of s

V = urine flow rate

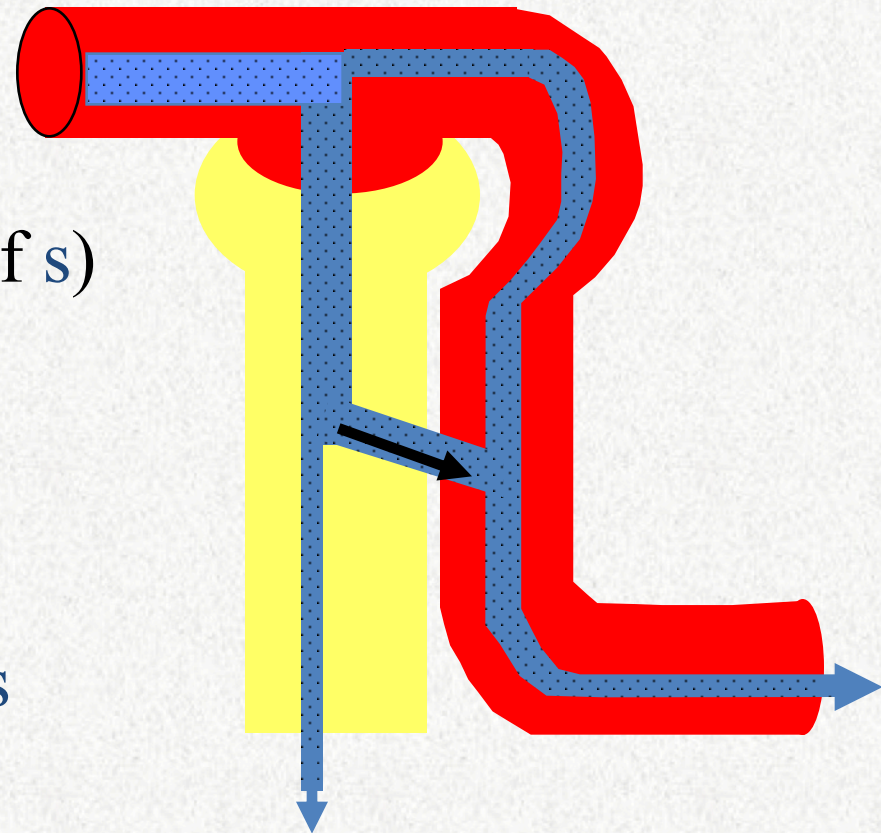

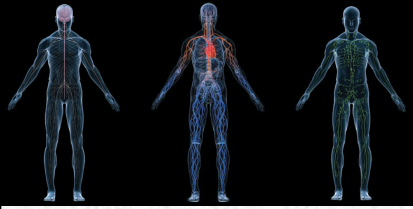

Calculation of Tubular Secretion

(when $\text{Excret } s > \text{Filt } s$)

$$\text{Secretion} = \text{Excretion} - \text{Filtration}$$

$$\text{Filt } s = \text{GFR} \times P_s$$

$$\text{Excret } s = U_s \times V$$

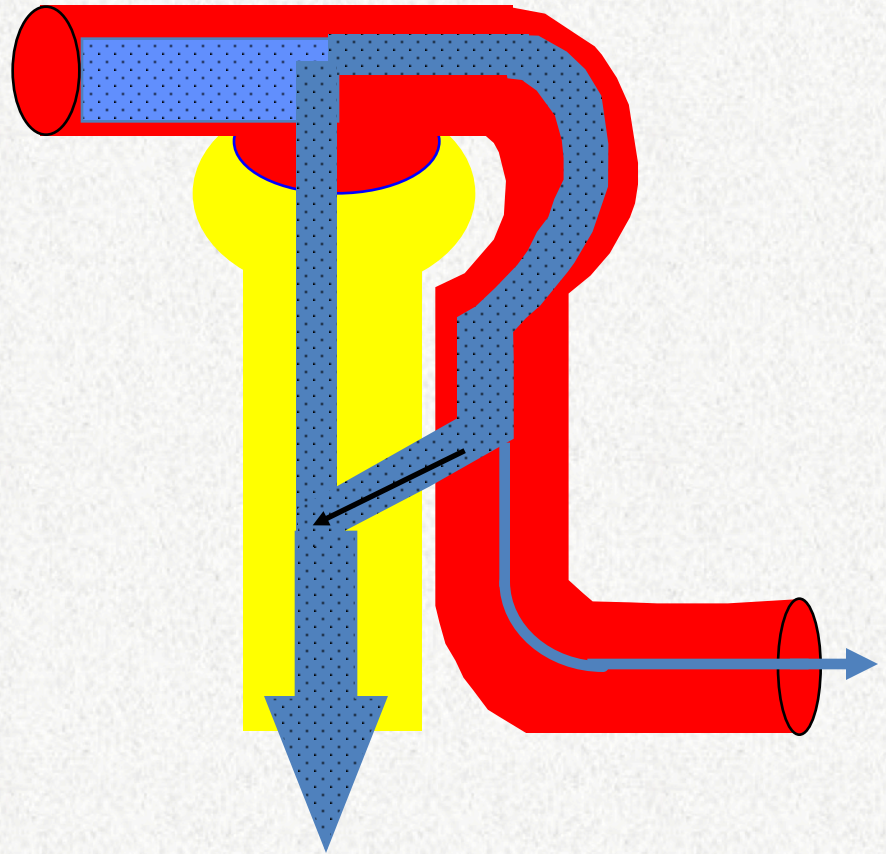

Example: Given the following data, calculate the rate of Na⁺ filtration, excretion, reabsorption, and secretion

$$\text{GFR} = 100 \text{ ml/min (0.1 L/min)}$$

$$P_{\text{Na}} = 140 \text{ mEq/L}$$

$$\text{urine flow} = 1 \text{ ml/min (.001 L/min)}$$

$$\text{urine Na conc} = 100 \text{ mEq/L}$$

$$\begin{aligned} \text{Filtration Na} &= \text{GFR} \times P_{\text{Na}} \\ &= 0.1 \text{ L/min} \times 140 \text{ mEq/L} = 14 \text{ mEq/min} \end{aligned}$$

$$\begin{aligned} \text{Excretion Na} &= \text{Urine flow rate} \times \text{Urine Na conc} \\ &= .001 \text{ L/min} \times 100 \text{ mEq/L} \\ &= 0.1 \text{ mEq/min} \end{aligned}$$

Example: Given the following data, calculate the rate of Na^+ filtration, excretion, reabsorption, and secretion

$$\text{GFR} = 100 \text{ ml/min};$$

$$P_{\text{Na}} = 140 \text{ mEq/L}$$

$$\text{urine flow} = 1 \text{ ml/min};$$

$$\text{urine Na conc} = 100 \text{ mEq/L}$$

$$\underline{\text{Filtration Na}} = 0.1 \text{ L/min} \times 140 \text{ mEq/L} = \underline{14 \text{ mEq/min}}$$

$$\underline{\text{Excretion Na}} = .001 \text{ L/min} \times 100 \text{ mEq/L} = \underline{0.1 \text{ mEq/min}}$$

$$\text{Reabsorption Na} = \text{Filtration Na} - \text{Excretion Na}$$

$$\text{Reabs Na} = 14.0 - 0.1 = 13.9 \text{ mEq/min}$$

Secretion Na = There is no net secretion of Na since
Excret Na < Filt Na

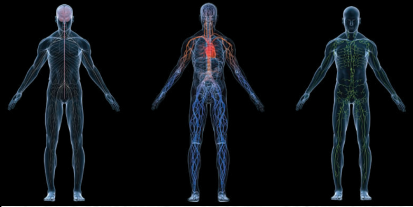

Transport Maximum

Some substances have a maximum rate of tubular transport due to saturation of carriers, limited ATP, etc

- **Transport Maximum:** Once the transport maximum is reached for all nephrons, further increases in tubular load are not reabsorbed and are excreted.
- **Threshold** is the tubular load at which transport maximum is exceeded in some nephrons. This is not exactly the same as the transport maximum of the whole kidney because some nephrons have lower transport max's than others.
- **Examples:** glucose, amino acids, phosphate, sulphate

A uninephrectomized patient with uncontrolled diabetes has a GFR of 90 ml/min, a plasma glucose of 200 mg% (2mg/ml), and a transport max (T_m) shown in the figure. What is the glucose excretion for this patient?

1. 0 mg/min
2. 30 mg/min
3. 60 mg/min
4. 90 mg/min
5. 120 mg/min

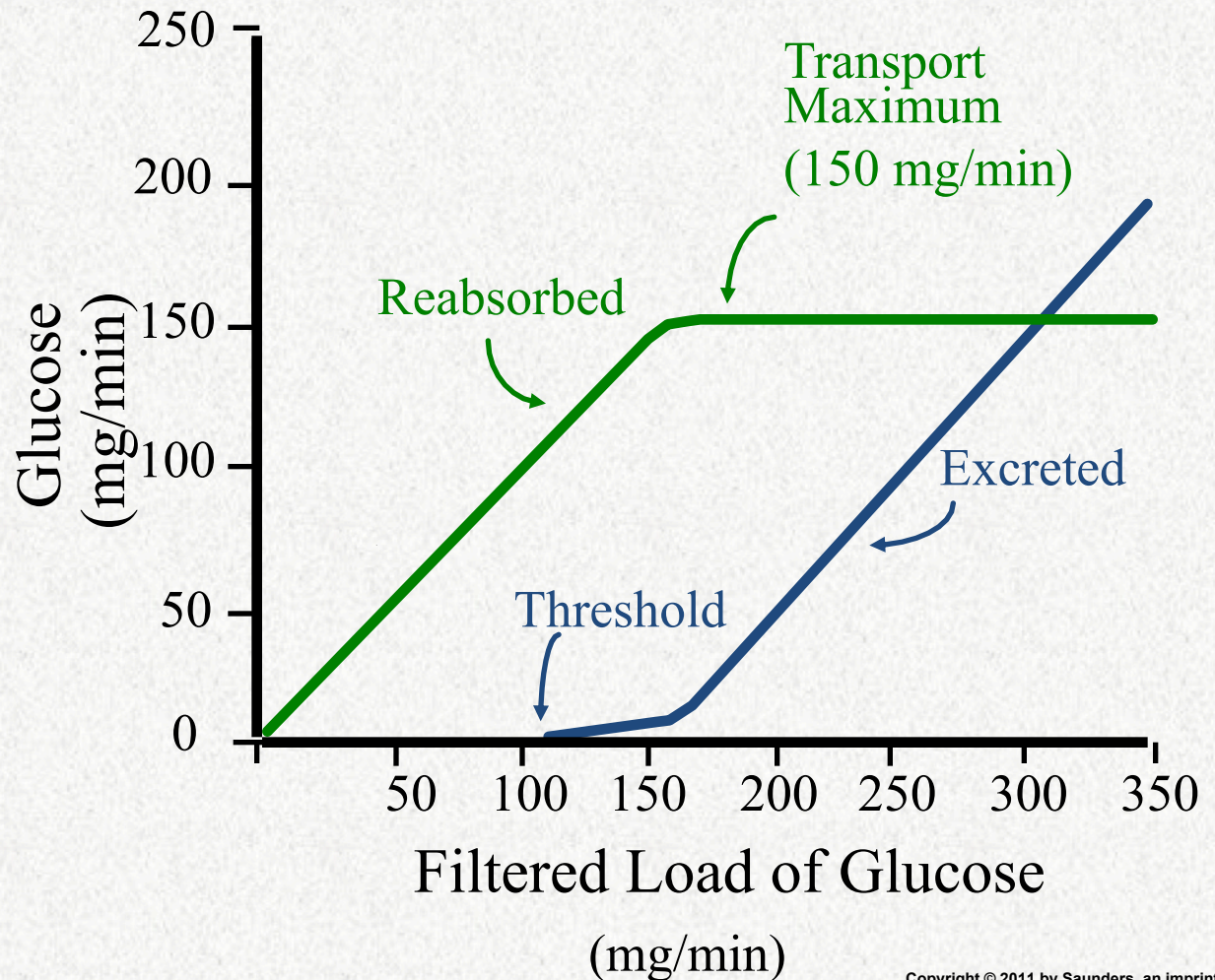

Answer: $\text{Filt}_{\text{Glu}} = (\text{GFR} \times P_{\text{Glu}}) = (90 \times 2) = 180 \text{ mg/min}$

$\text{Reabs}_{\text{Glu}} = T_{\text{max}} = 150 \text{ mg/min}$

$\text{Excret}_{\text{Glu}} = \underline{30 \text{ mg/min}}$

$\text{GFR} = 90 \text{ ml/min}$

$P_{\text{Glu}} = 2 \text{ mg/ml}$

$T_{\text{max}} = 150 \text{ mg/min}$

a. 0 mg/min

b. 30 mg/min

c. 60 mg/min

d. 90 mg/min

e. 120 mg/min

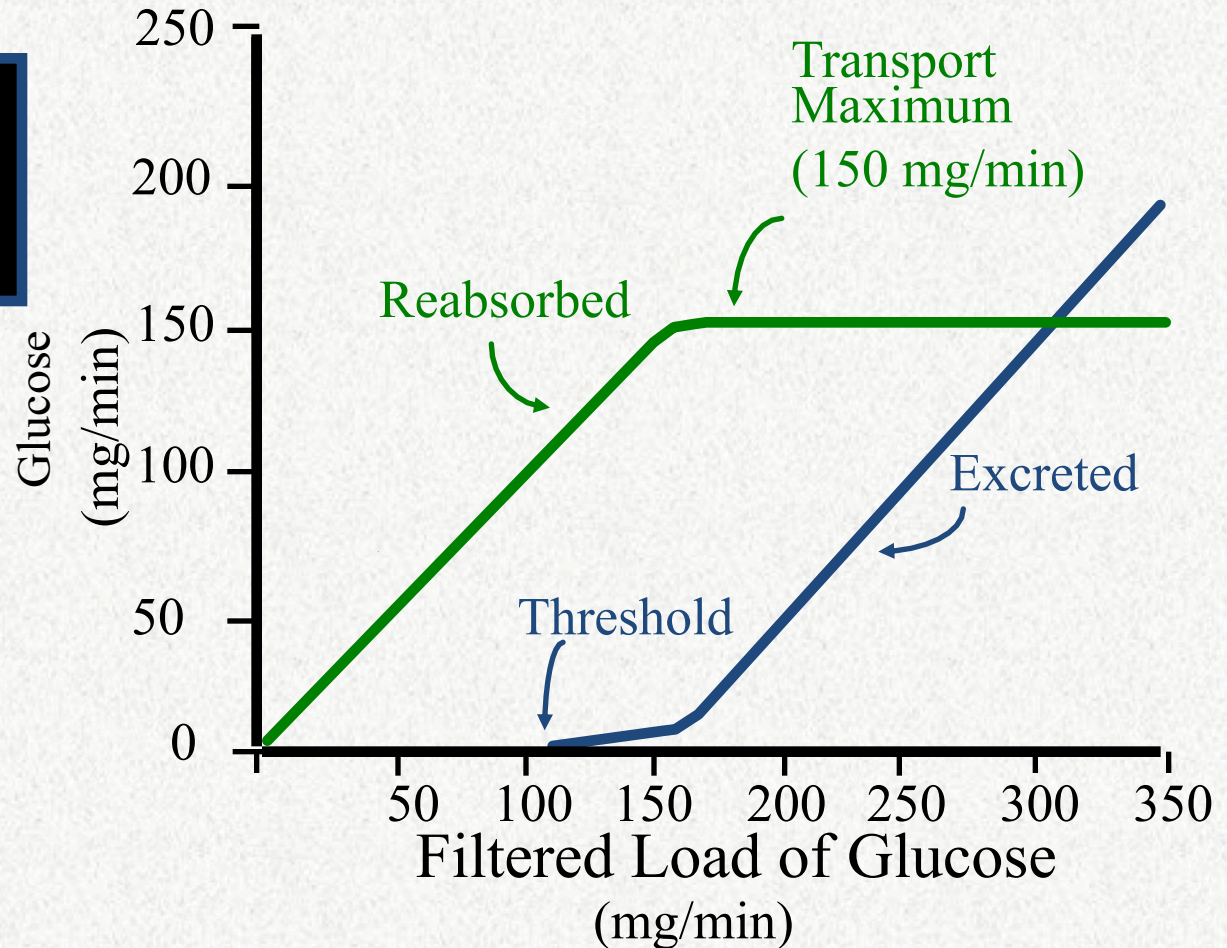

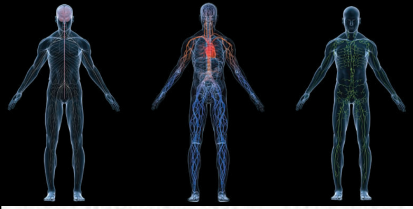

Peritubular Capillary Reabsorption

$$\begin{aligned} \text{Reabs} &= \text{Net Reabs Pressure (NRP)} \times K_f \\ &= (10 \text{ mmHg}) \times (12.4 \text{ ml/min/mmHg}) \end{aligned}$$

$$\text{Reabs} = 124 \text{ ml/min}$$

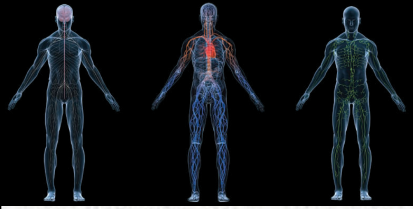

Determinants of Peritubular Capillary Reabsorption

↑ K_f → ↑ Reabsorption

↑ P_c → ↓ Reabsorption

↑ Π_c → ↑ Reabsorption

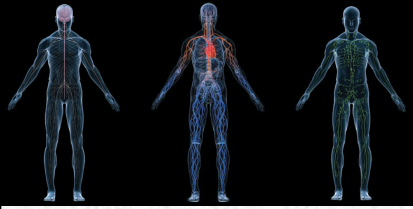

Determinants of Peritubular Capillary Hydrostatic Pressure

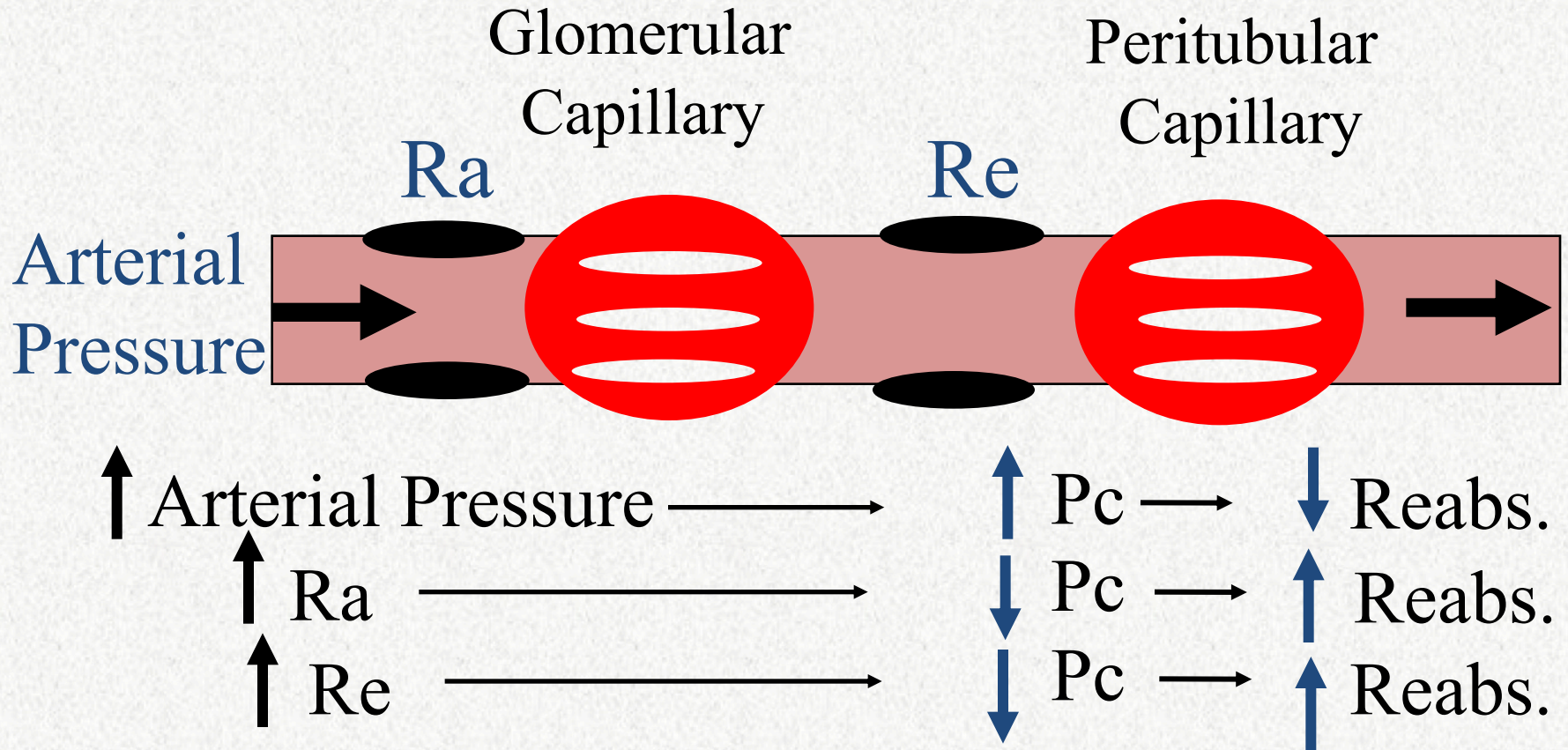

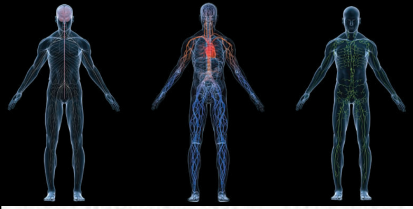

Determinants of Peritubular Capillary Colloid Osmotic Pressure

$\uparrow \Pi_c \longrightarrow \uparrow \text{Reabsorption}$

$\uparrow \text{Plasm. Prot.} \longrightarrow \uparrow \Pi_a \longrightarrow \uparrow \Pi_c$
 $\uparrow \text{Filt. Fract.} \longrightarrow \uparrow \Pi_c$

$$\text{Filt. Fract.} = \text{GFR} / \text{RPF}$$

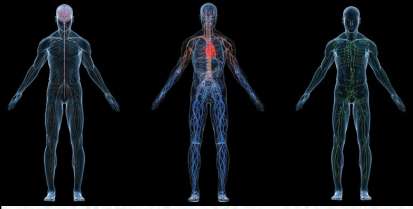

Factors That Can Influence Peritubular Capillary Reabsorption

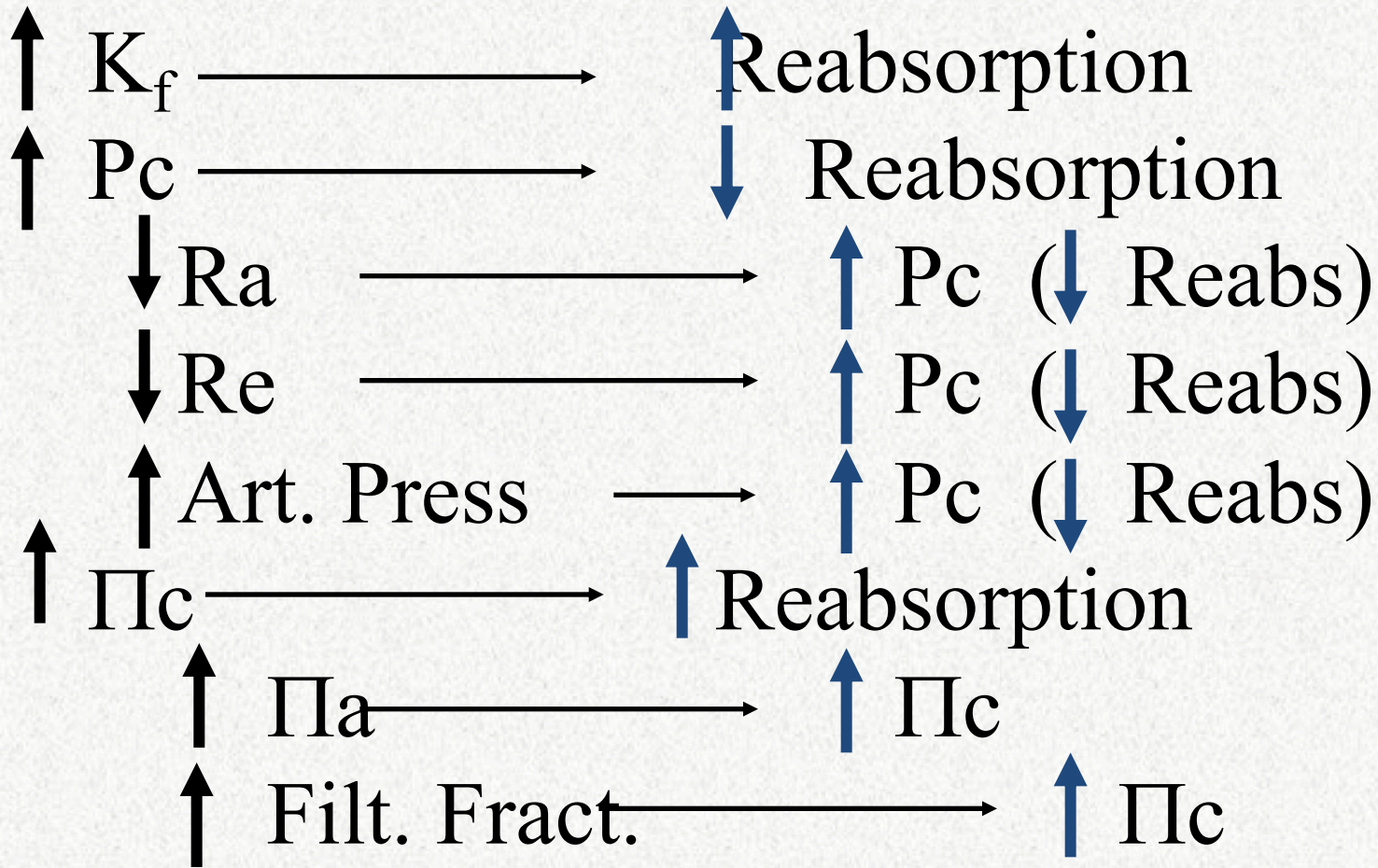

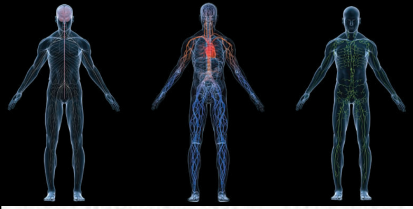

Effect of increased hydrostatic pressure or decreased colloid osmotic pressure in peritubular capillaries to reduce reabsorption

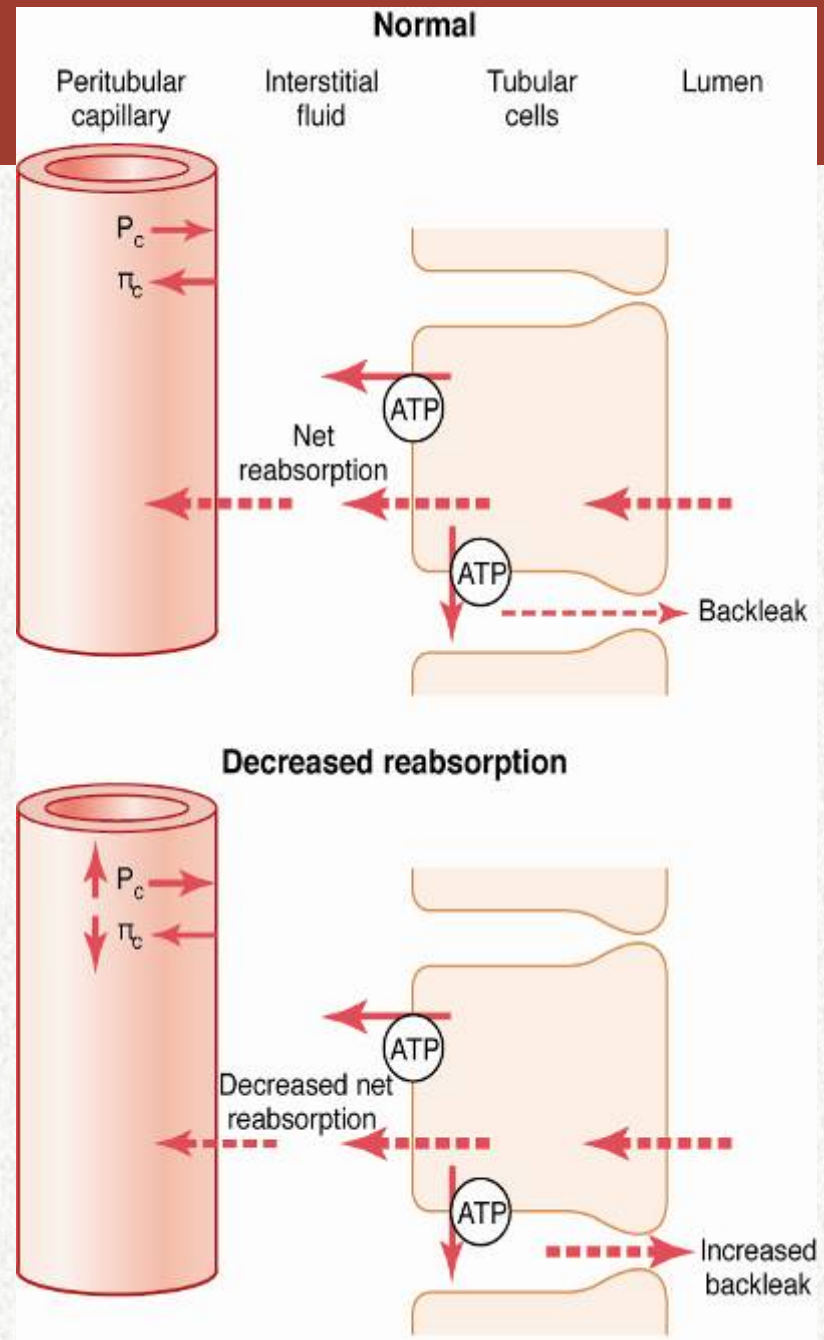
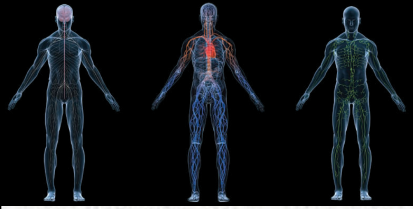
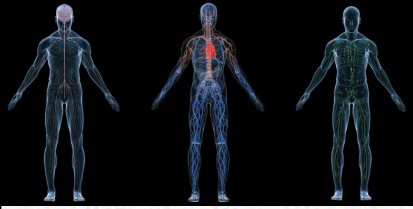

Figure 27-16



Aldosterone actions on late distal, cortical and medullary collecting tubules

- Increases Na^+ reabsorption - principal cells
- Increases K^+ secretion - principal cells
- Increases H^+ secretion - intercalated cells



Late Distal, Cortical and Medullary Collecting Tubules

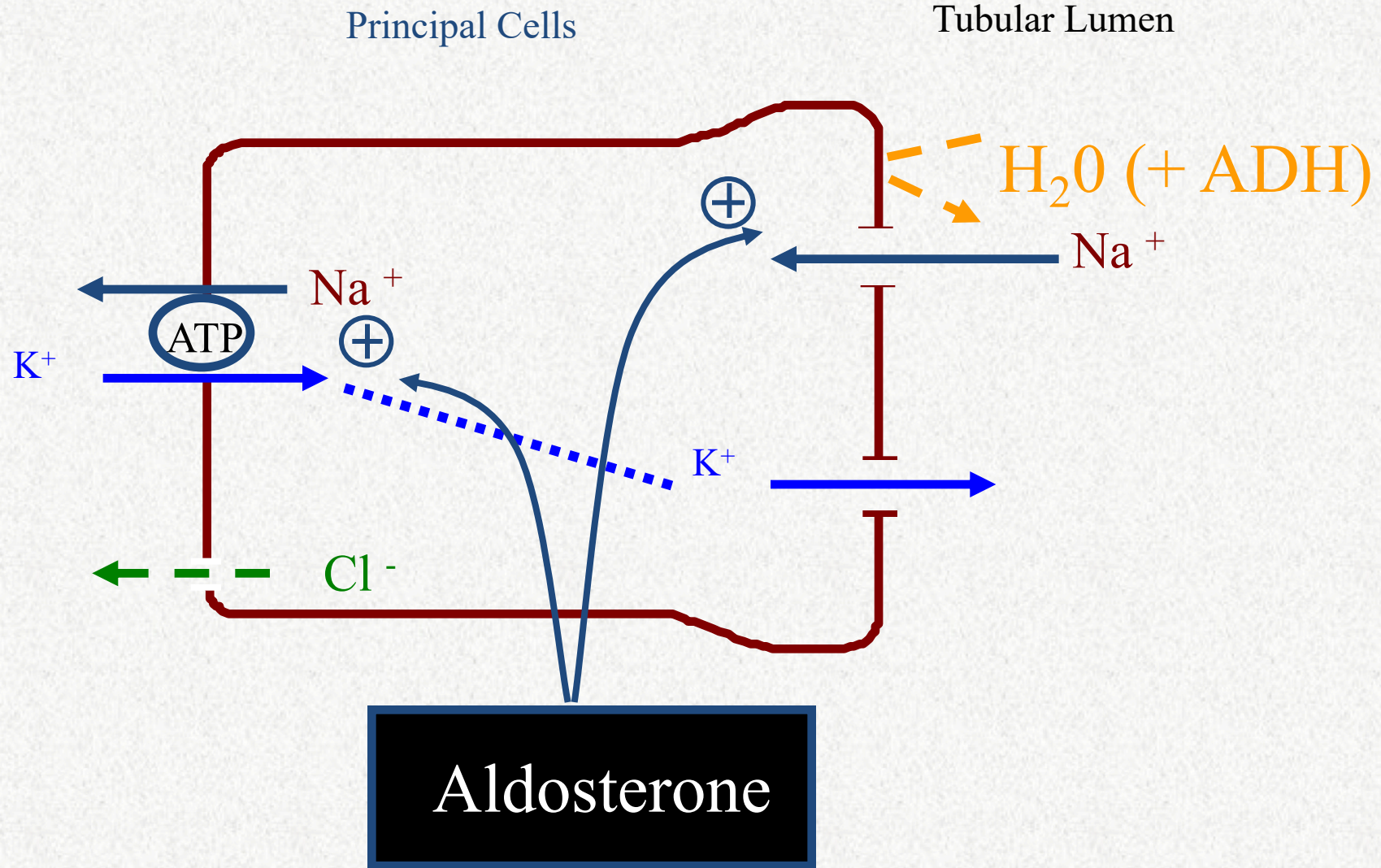

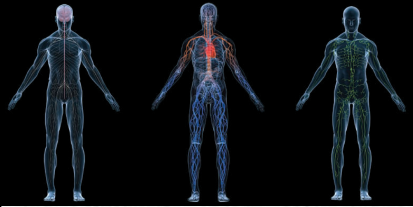

Abnormal Aldosterone Production

- Excess aldosterone (**Primary aldosteronism**
Conn's syndrome) - Na^+ retention,
hypokalemia, alkalosis, hypertension
- Aldosterone deficiency - **Addison's disease**
 Na^+ wasting, hyperkalemia, hypotension

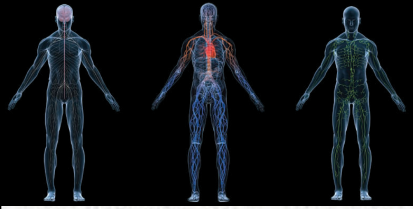

Control of Aldosterone Secretion

Factors that increase aldosterone secretion

- Angiotensin II
- Increased K^+
- adrenocorticotrophic hormone (ACTH)
(permissive role)

Factors that decrease aldosterone secretion

- Atrial natriuretic factor (ANF)
- Increased Na^+ concentration (osmolality)

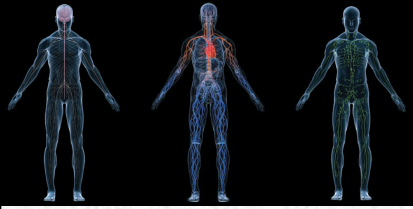

Angiotensin II Increases Na^+ and Water Reabsorption

- Stimulates aldosterone secretion
- Directly increases Na^+ reabsorption (proximal, loop, distal, collecting tubules)
- Constricts efferent arterioles
 - decreases peritubular capillary hydrostatic pressure
 - increases filtration fraction, which increases peritubular colloid osmotic pressure)

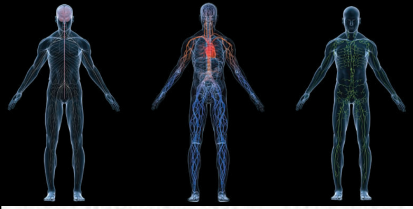

Angiotensin II increases renal tubular sodium reabsorption

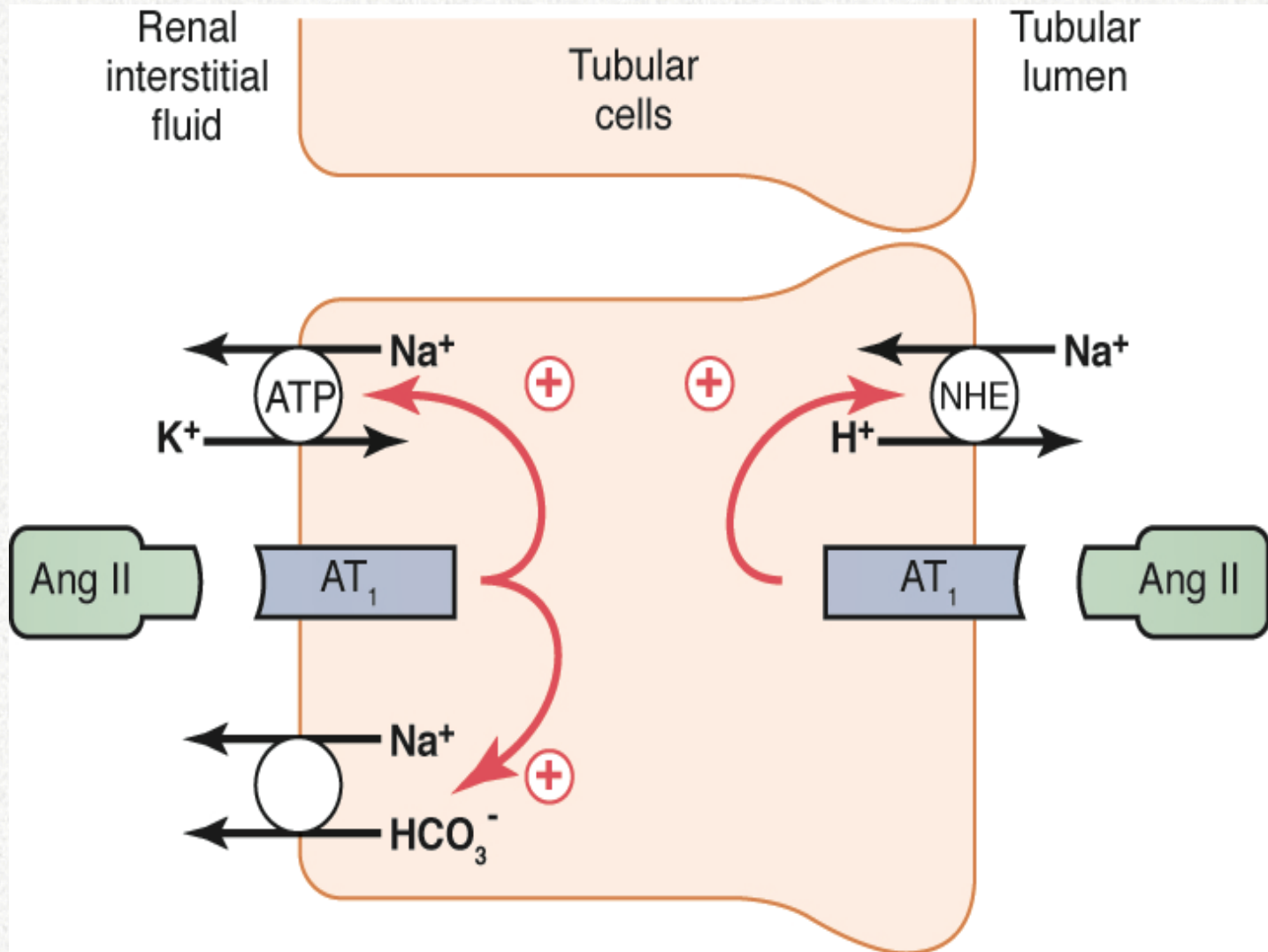
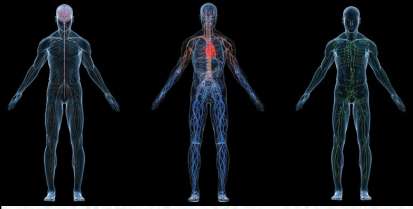
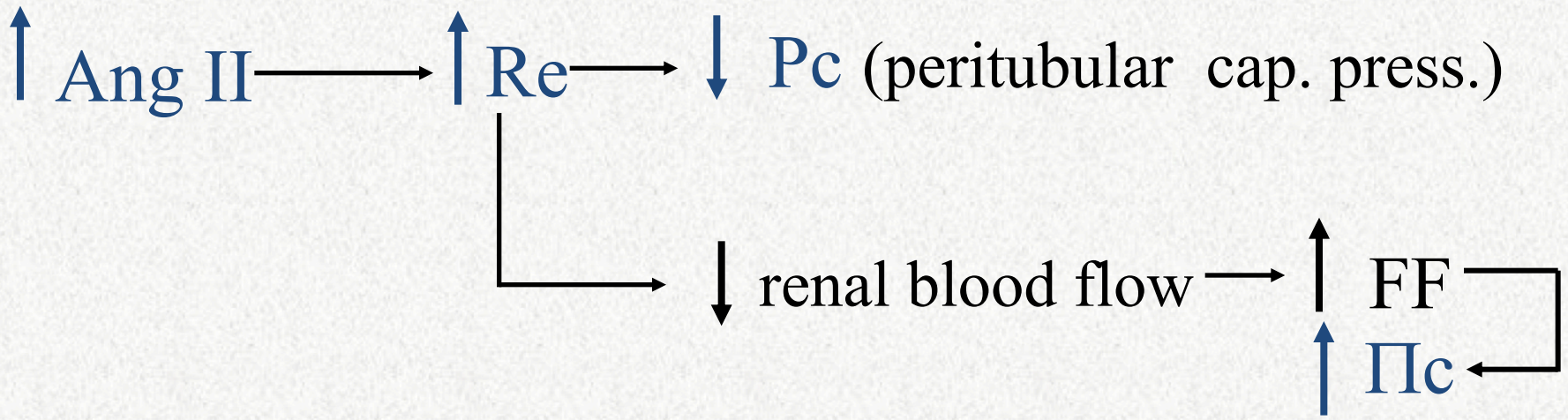
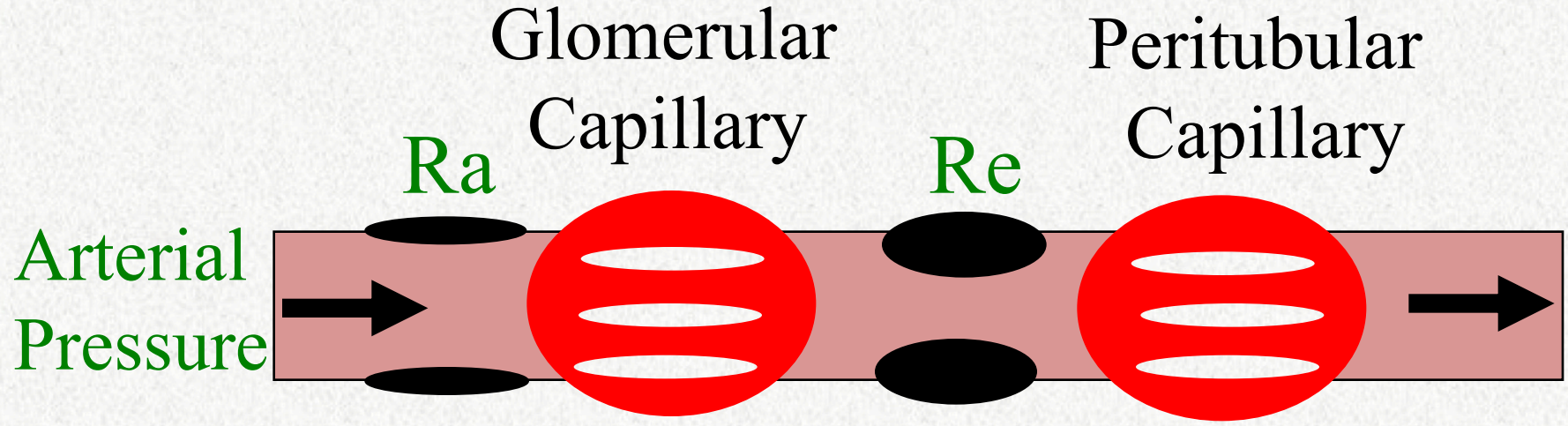
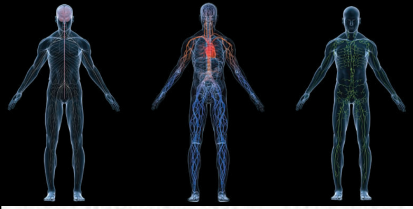

Figure 27-17



Effect of Angiotensin II on Peritubular Capillary Dynamics





Ang II constriction of efferent arterioles causes Na^+ and water retention and maintains excretion of waste products

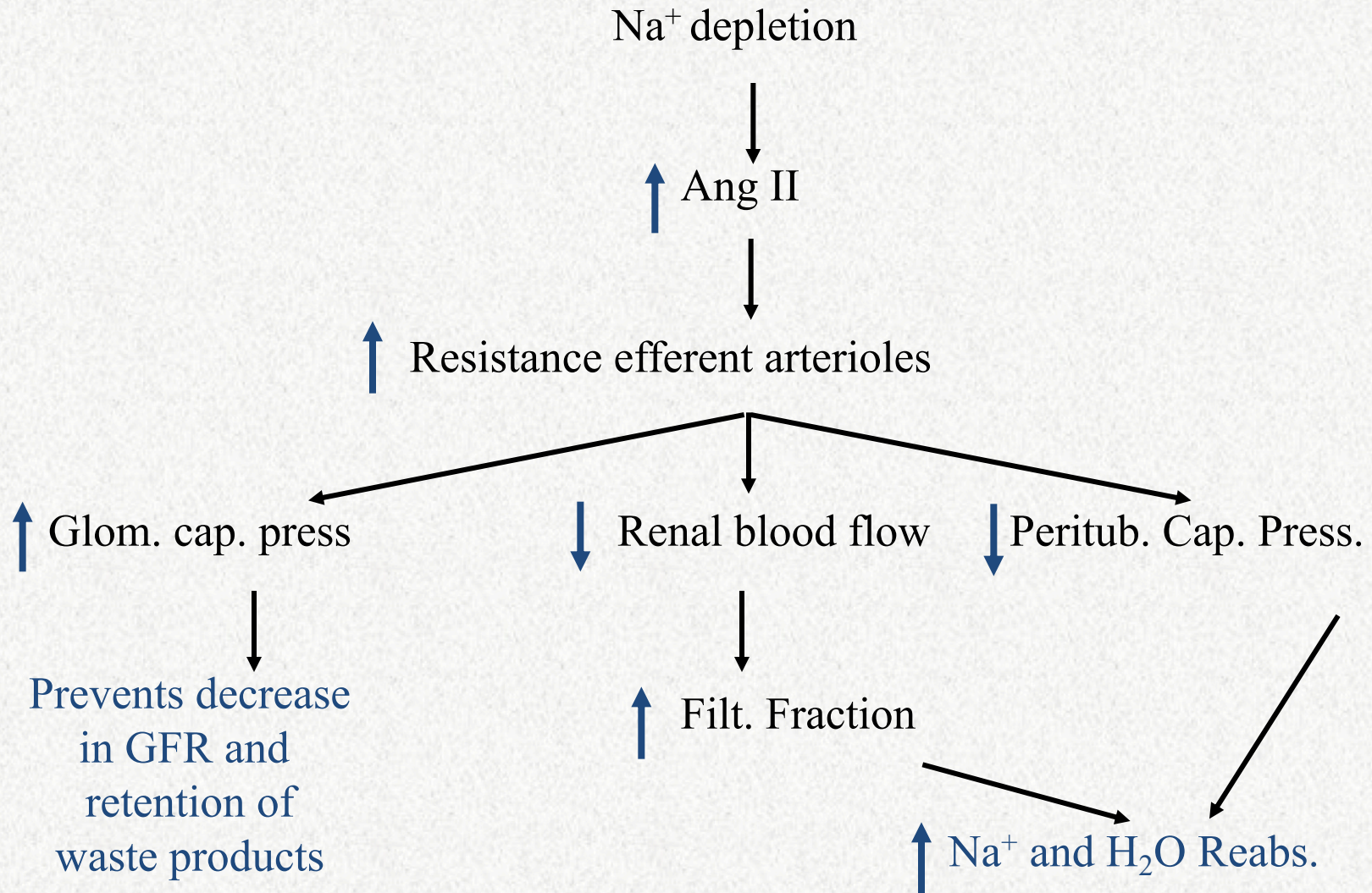

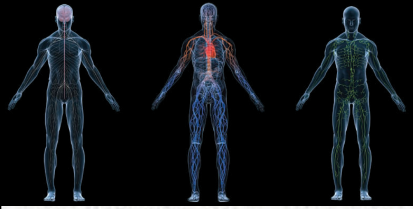

Angiotensin II blockade decreases Na⁺ reabsorption and blood pressure

- ACE inhibitors (captopril, benazepril, ramipril)
- Ang II antagonists (losartan, candesartan, irbesartan)
- Renin inhibitors (aliskirin)
 - decrease aldosterone
 - directly inhibit Na⁺ reabsorption
 - decrease efferent arteriolar resistance



Natriuresis and Diuresis + ↓ Blood Pressure

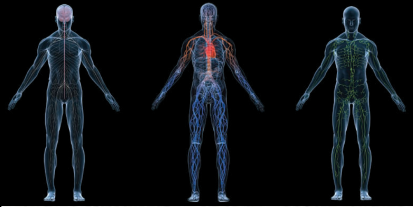

Antidiuretic Hormone (ADH)

- Secreted by posterior pituitary
- Increases H_2O permeability and reabsorption in distal and collecting tubules
- Allows differential control of H_2O and solute excretion
- Important controller of extracellular fluid osmolarity

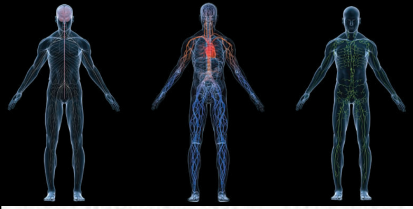

ADH synthesis in the magnocellular neurons of hypothalamus, release by the posterior pituitary, and action on the kidneys

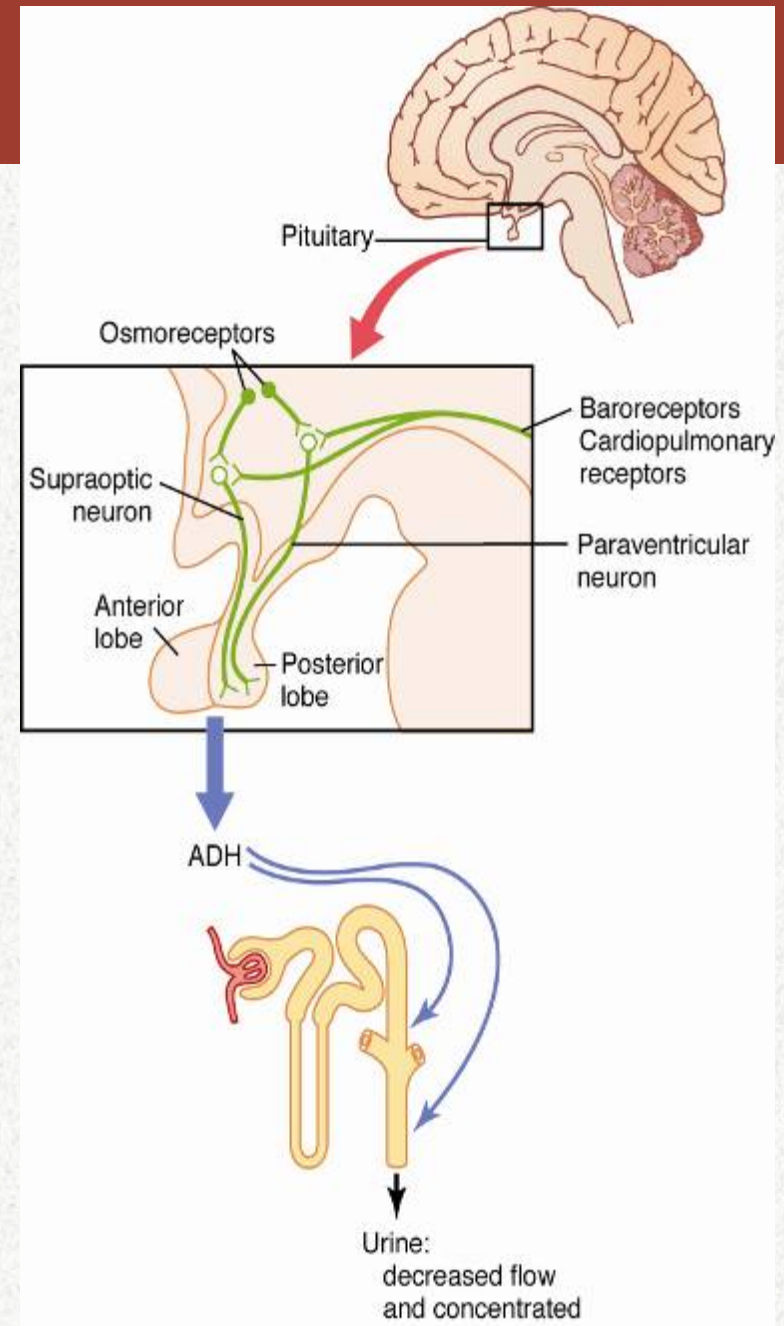
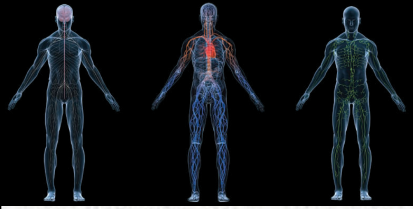

Figure 28-10



Mechanism of action of ADH in distal and collecting tubules

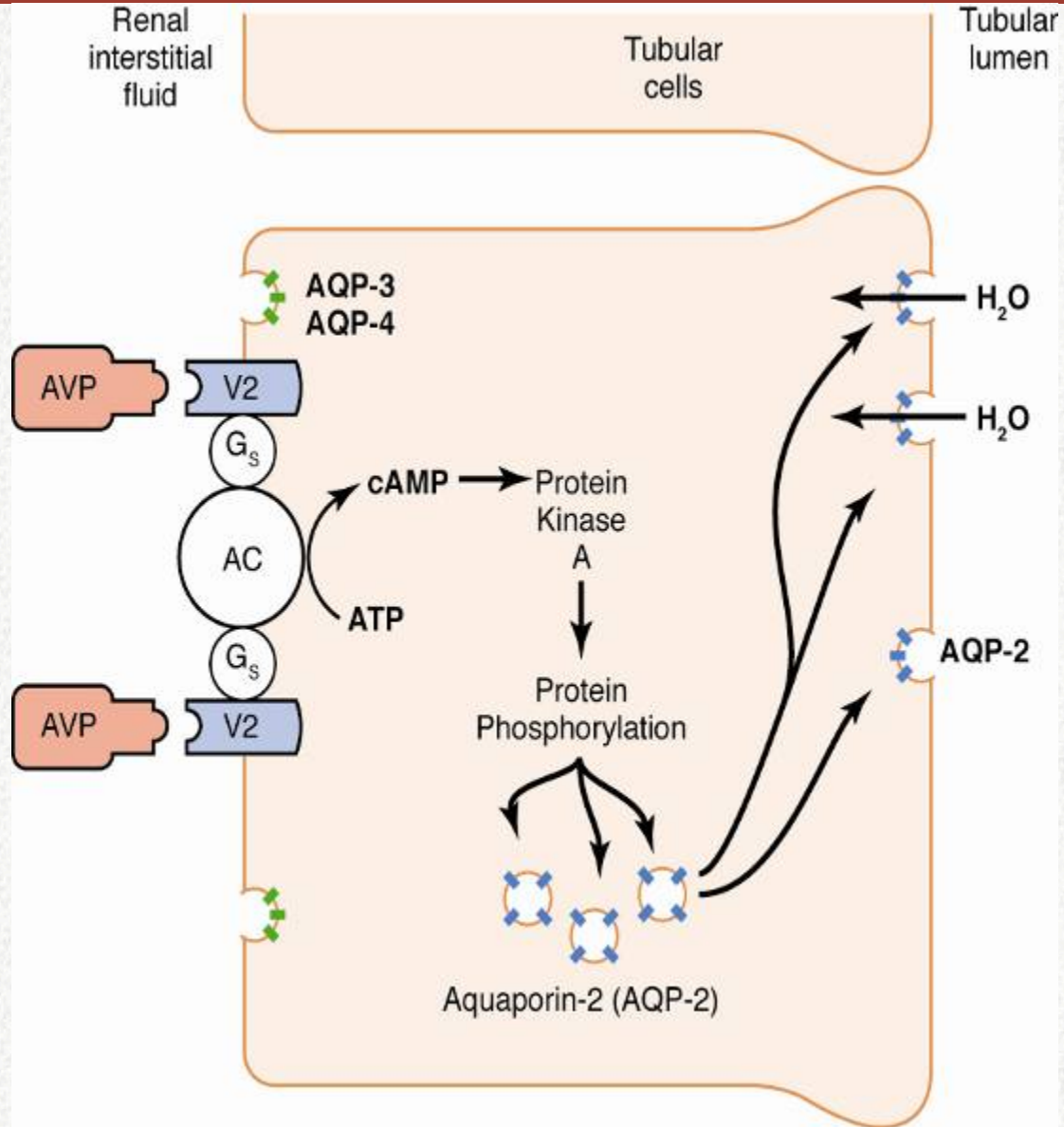
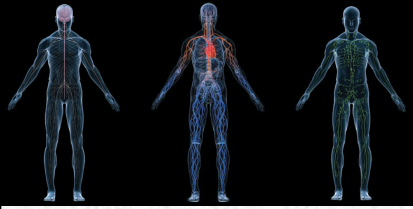
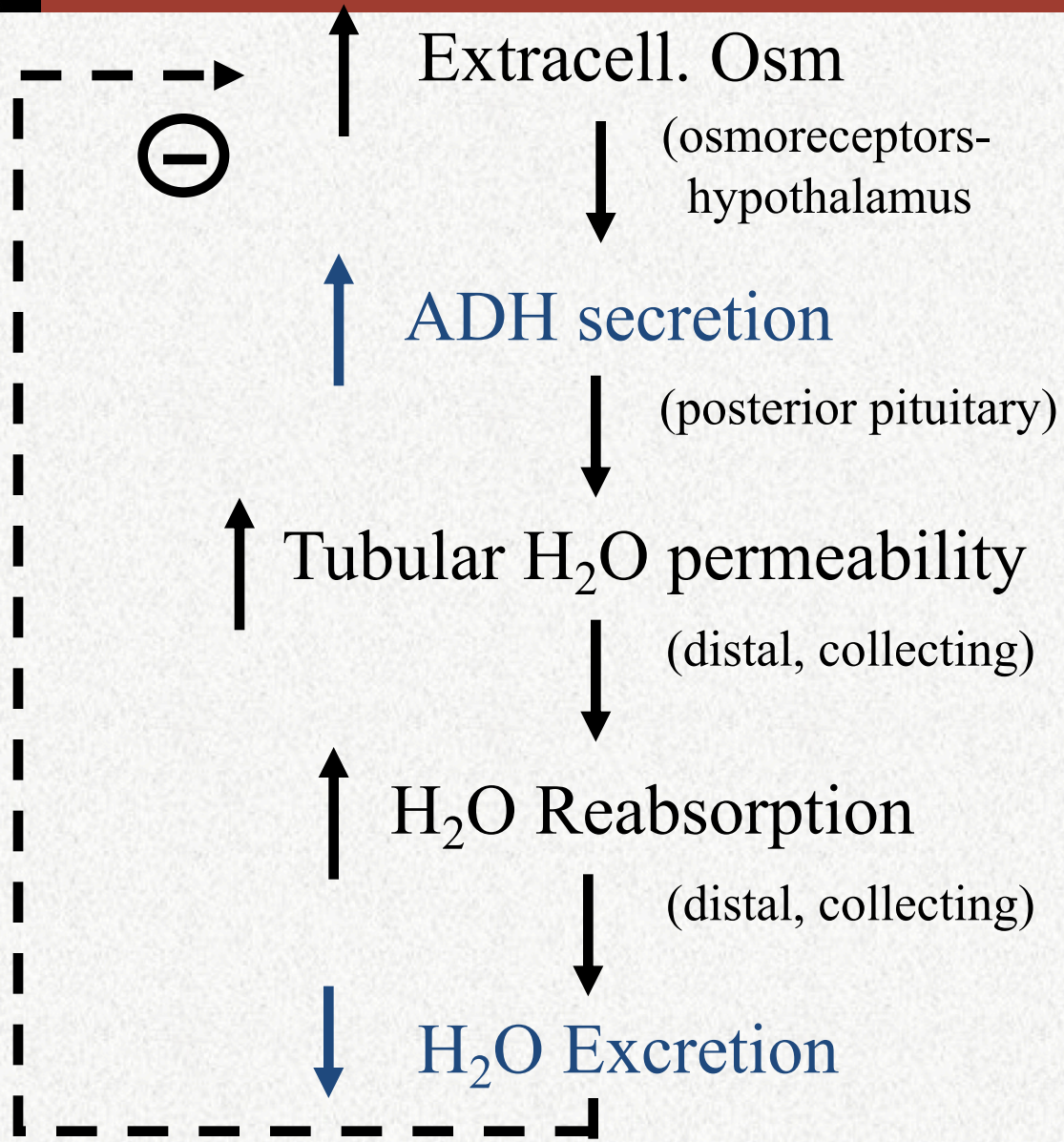
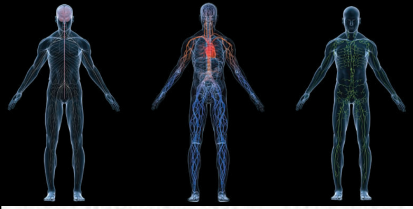

Figure 28-18



Feedback Control of Extracellular Fluid Osmolarity by ADH





Abnormalities of ADH

- **Inappropriate ADH syndrome (excess ADH)**
 - decreased plasma osmolarity, hyponatremia
- **“Central” Diabetes insipidus (insufficient ADH)**
 - increased plasma osmolarity, hypernatremia, excess thirst

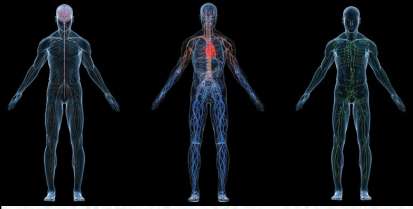

Atrial natriuretic peptide increases Na^+ excretion

- Secreted by cardiac atria in response to stretch (increased blood volume)
- Directly inhibits Na^+ reabsorption
- Inhibits renin release and aldosterone formation
- Increases GFR
- Helps to minimize blood volume expansion

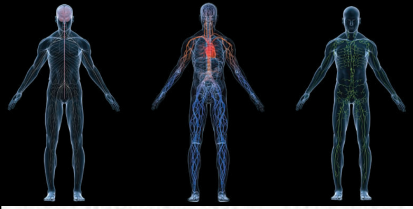

Atrial Natriuretic Peptide (ANP)

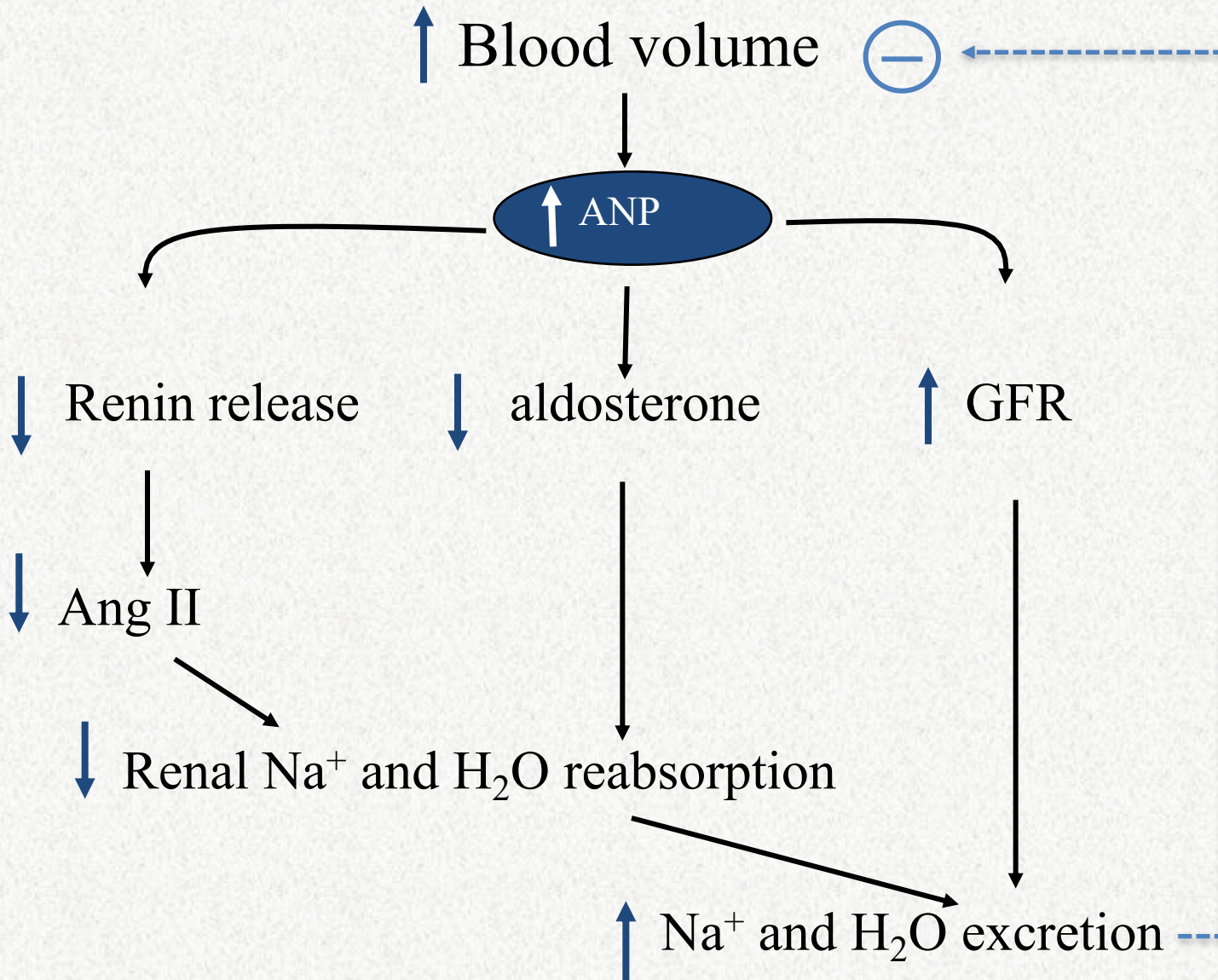

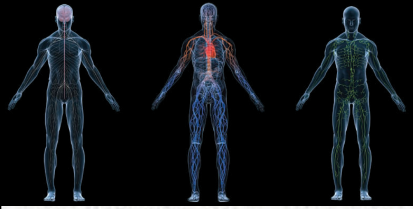

Parathyroid hormone increases renal Ca^{++} reabsorption

- Released by parathyroids in response to decreased extracellular Ca^{++}
- Increases Ca^{++} reabsorption by kidneys
- Increases Ca^{++} reabsorption by gut
- Decreases phosphate reabsorption
- Helps to increase extracellular Ca^{++}

(see chapter 29)

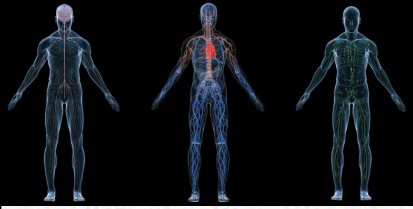

Control of Ca^{++} by Parathyroid Hormone

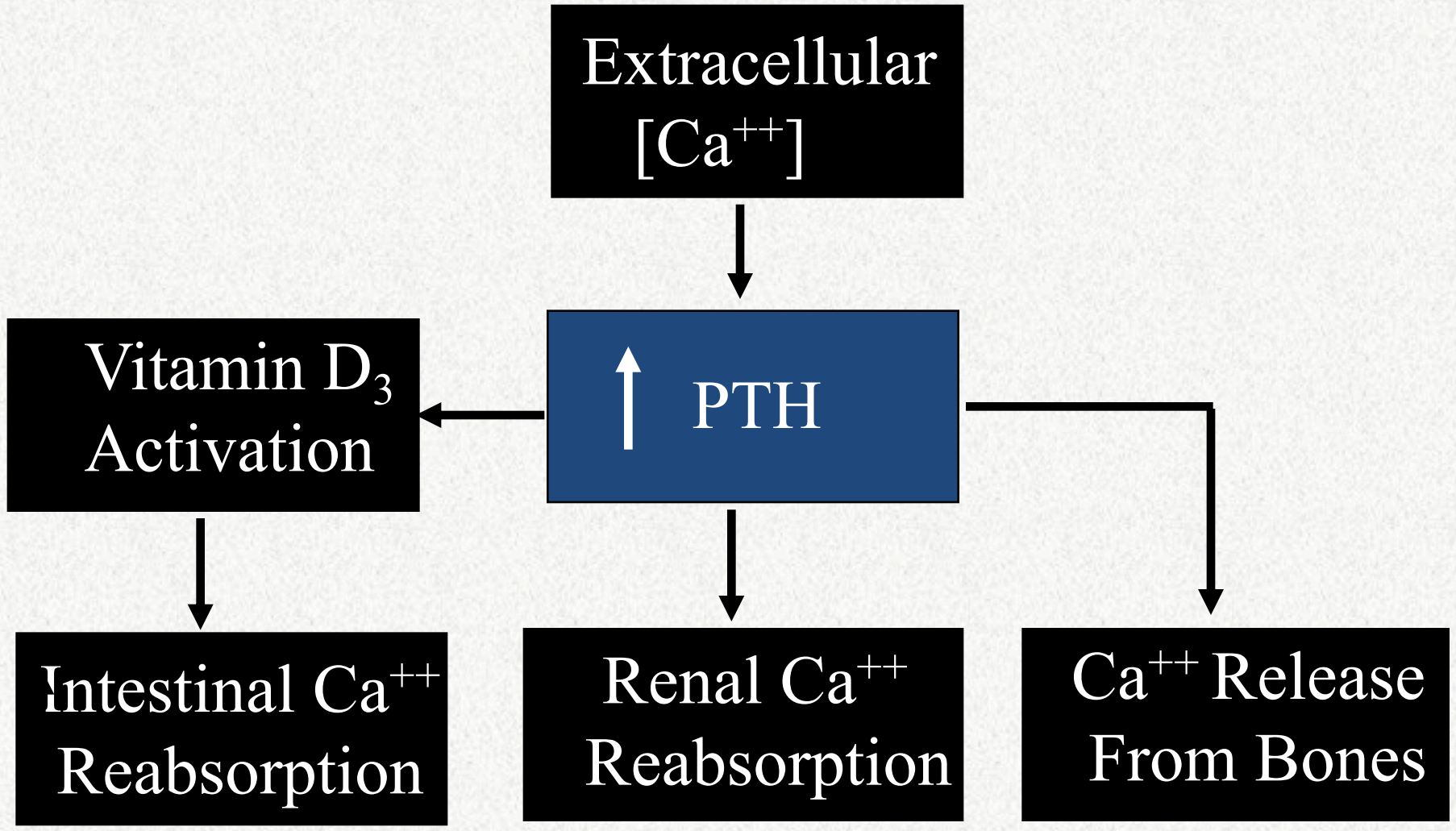

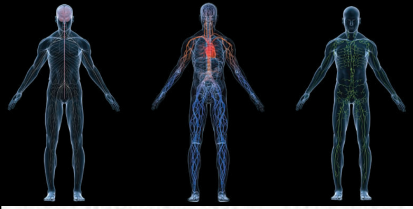

Sympathetic nervous system increases Na^+ reabsorption

- Directly stimulates Na^+ reabsorption
- Stimulates renin release
- Decreases GFR and renal blood flow
(only a high levels of sympathetic stimulation)

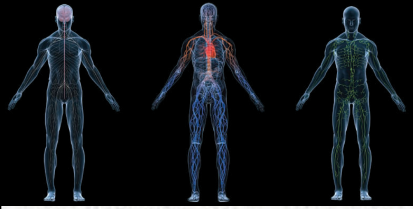

Renal Pressure Natriuresis

Urinary Sodium Output (x normal)

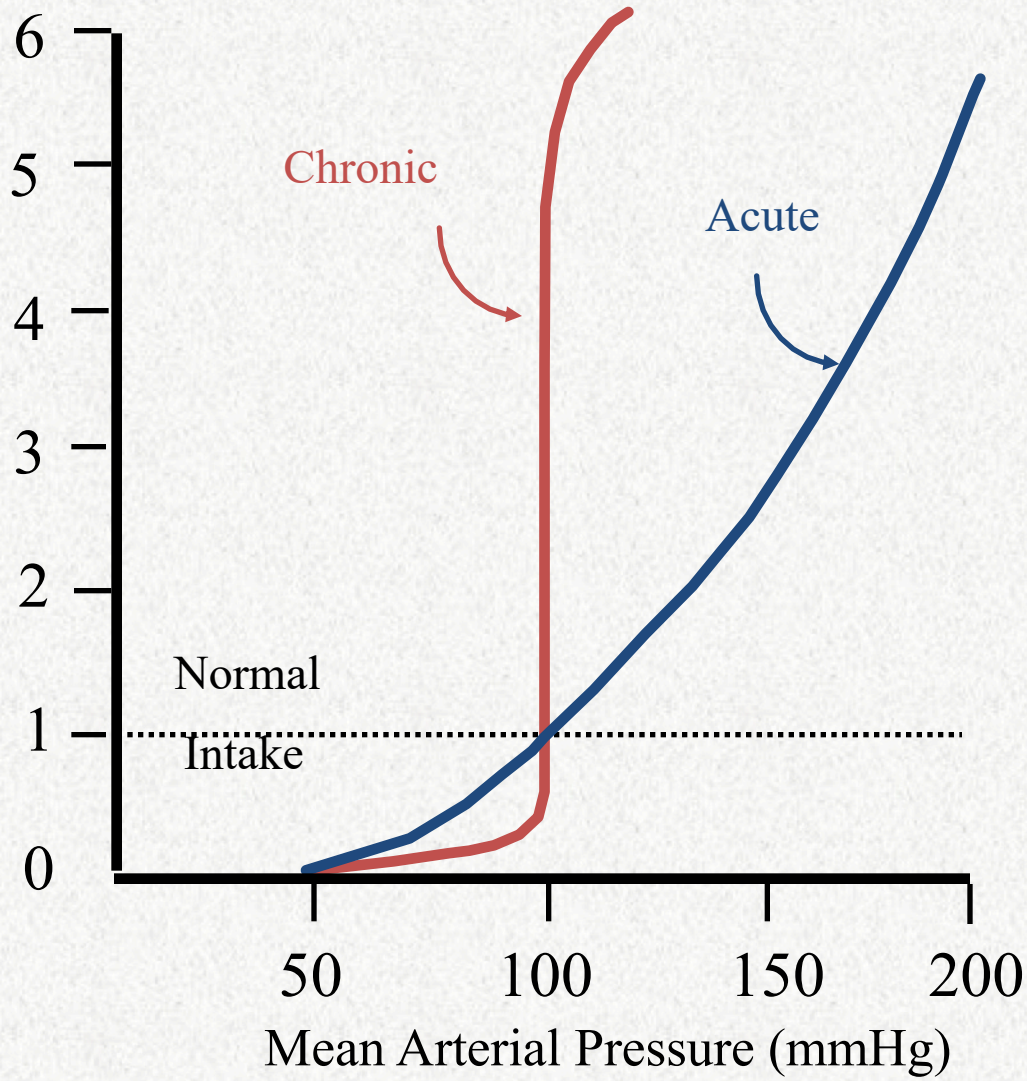

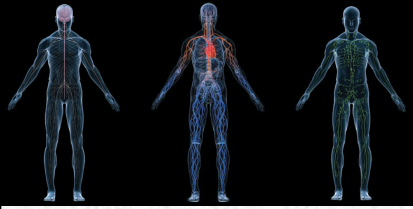

Increased Arterial Pressure Decreases Na^+ Reabsorption (Pressure Natriuresis)

- Increased peritubular capillary hydrostatic pressure
- Decreased renin and aldosterone
- Increased release of intrarenal natriuretic factors
 - prostaglandins
 - EDRF

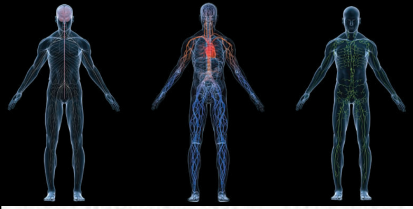

Osmotic Effects on Reabsorption

- Water is reabsorbed only by osmosis
- Increasing the amount of unreabsorbed solutes in the tubules decreases water reabsorption

i.e. diabetes mellitus : unreabsorbed glucose in tubules causes diuresis and water loss

i.e. osmotic diuretics (mannitol)

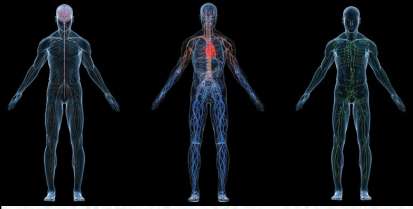

Assessing Kidney Function

- Plasma concentration of waste products (e.g. BUN, creatinine)
- Urine specific gravity, urine concentrating ability;
- Urinalysis test reagent strips (protein, glucose, etc)
- Biopsy
- Albumin excretion (microalbuminuria)
- Isotope renal scans
- Imaging methods (e.g. MRI, PET, arteriograms, iv pyelography, ultrasound etc)
- Clearance methods (e.g. 24-hr creatinine clearance)
- etc

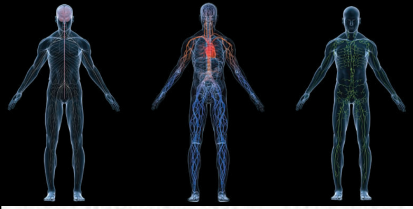

Clearance

- “Clearance” describes the rate at which substances are removed (cleared) from the plasma.
- Renal clearance of a substance is the volume of plasma completely cleared of a substance per min by the kidneys.

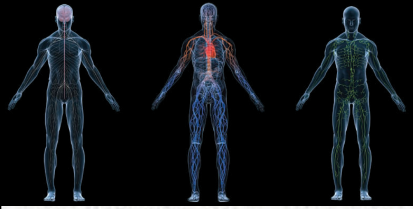

Clearance Technique

Renal clearance (C_s) of a substance is the **volume** of plasma completely cleared of a substance per min.

$$C_s \times P_s = U_s \times V$$

$$C_s = \frac{U_s \times V}{P_s} = \frac{\text{urine excretion rate}}{\text{Plasma conc. } s}$$

Where : C_s = clearance of substance S

P_s = plasma conc. of substance S

U_s = urine conc. of substance S

V = urine flow rate

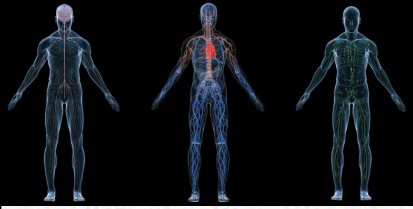

Clearances of Different Substances

Substance	Clearance (ml/min)
glucose	0
albumin	0
sodium	0.9
urea	70
inulin	125
creatinine	140
PAH	600

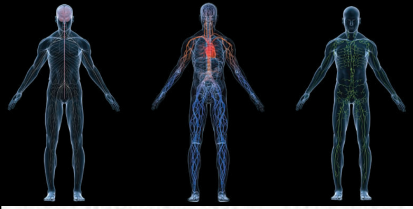

Use of Clearance to Measure GFR

For a substance that is freely filtered, but not reabsorbed or secreted (inulin, ¹²⁵I-iothalamate, creatinine), renal clearance is equal to GFR

amount filtered = amount excreted

$$\text{GFR} \times P_{\text{in}} = U_{\text{in}} \times V$$

$$\text{GFR} = \frac{U_{\text{in}} \times V}{P_{\text{in}}}$$

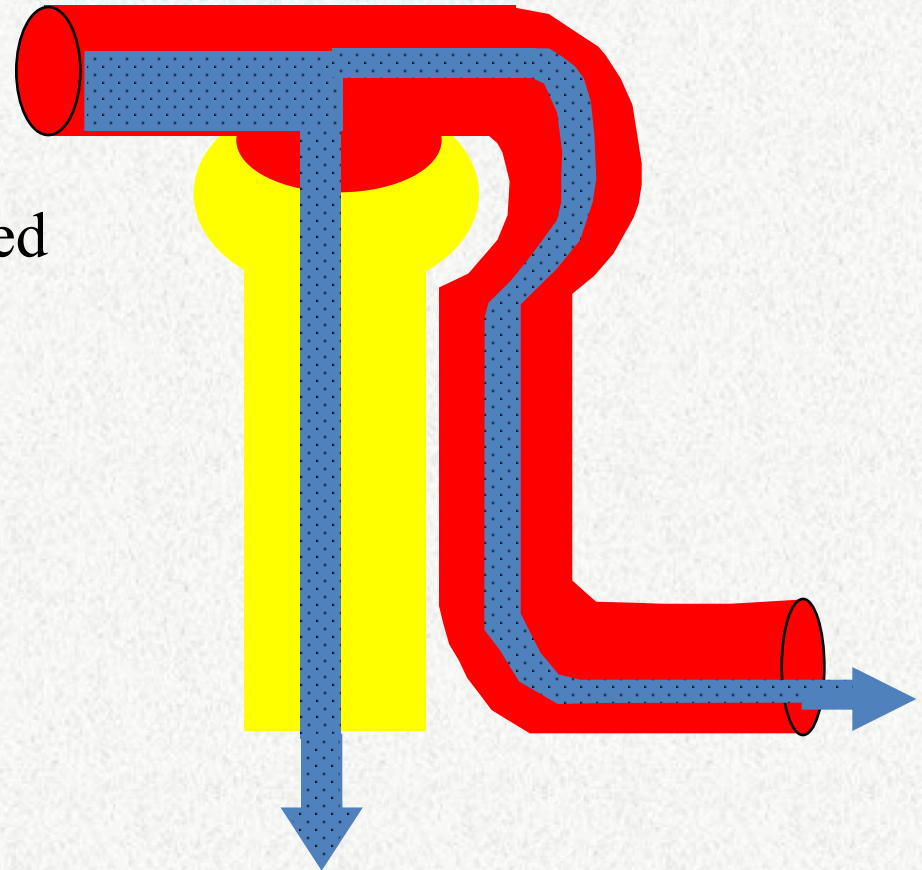

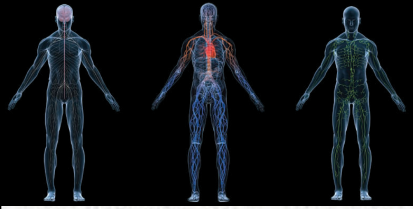

Calculate the GFR from the following data:

$$P_{\text{inulin}} = 1.0 \text{ mg} / 100\text{ml}$$

$$U_{\text{inulin}} = 125 \text{ mg}/100 \text{ ml}$$

$$\text{Urine flow rate} = 1.0 \text{ ml}/\text{min}$$

$$\text{GFR} = C_{\text{inulin}} = \frac{U_{\text{in}} \times V}{P_{\text{in}}}$$

$$\text{GFR} = \frac{125 \times 1.0}{1.0} = 125 \text{ ml}/\text{min}$$

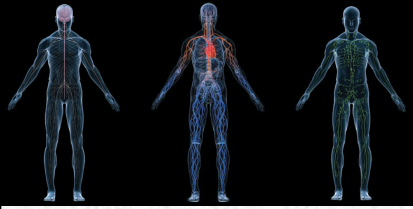

Use of Clearance to Estimate Renal Plasma Flow

Theoretically, if a substance is completely cleared from the plasma, its clearance rate would equal renal plasma flow

$C_x = \text{renal plasma flow}$

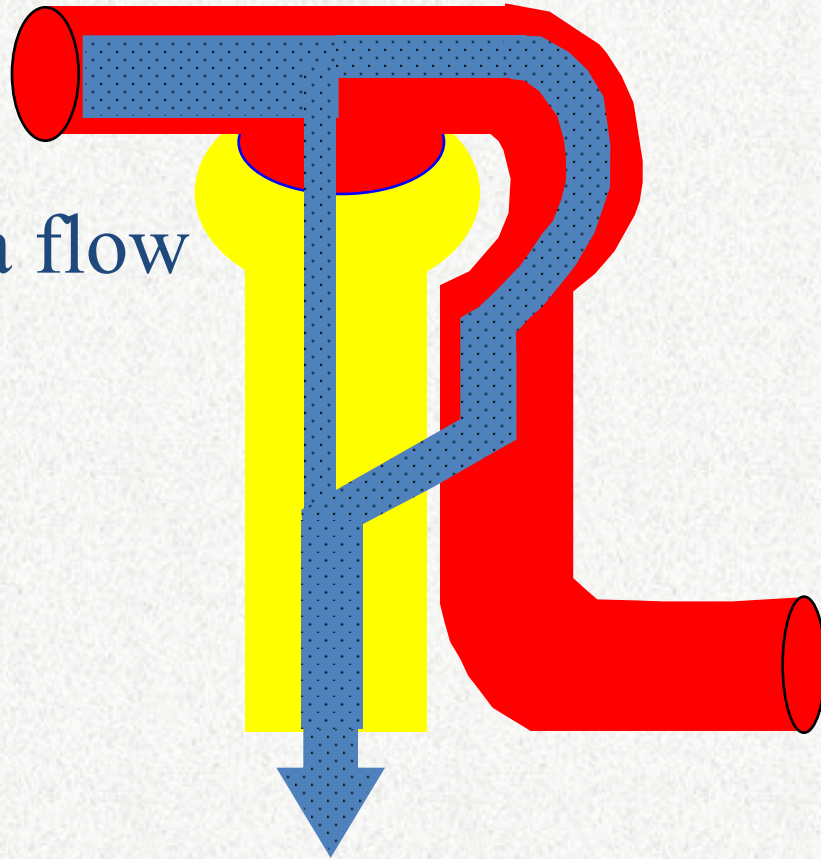

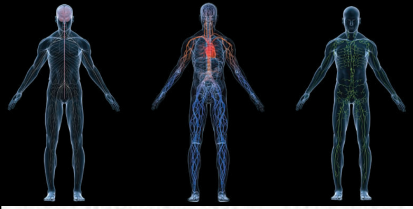

Use of PAH Clearance to Estimate Renal Plasma Flow

Paraminohippuric acid (PAH) is freely filtered and secreted and is almost completely cleared from the renal plasma

1. amount enter kidney =
 $RPF \times P_{PAH}$

2. amount entered \cong amount excreted

3. $ERPF \times P_{pah} = U_{PAH} \times V$

$$ERPF = \frac{U_{PAH} \times V}{P_{PAH}}$$

$$ERPF = \text{Clearance PAH}$$

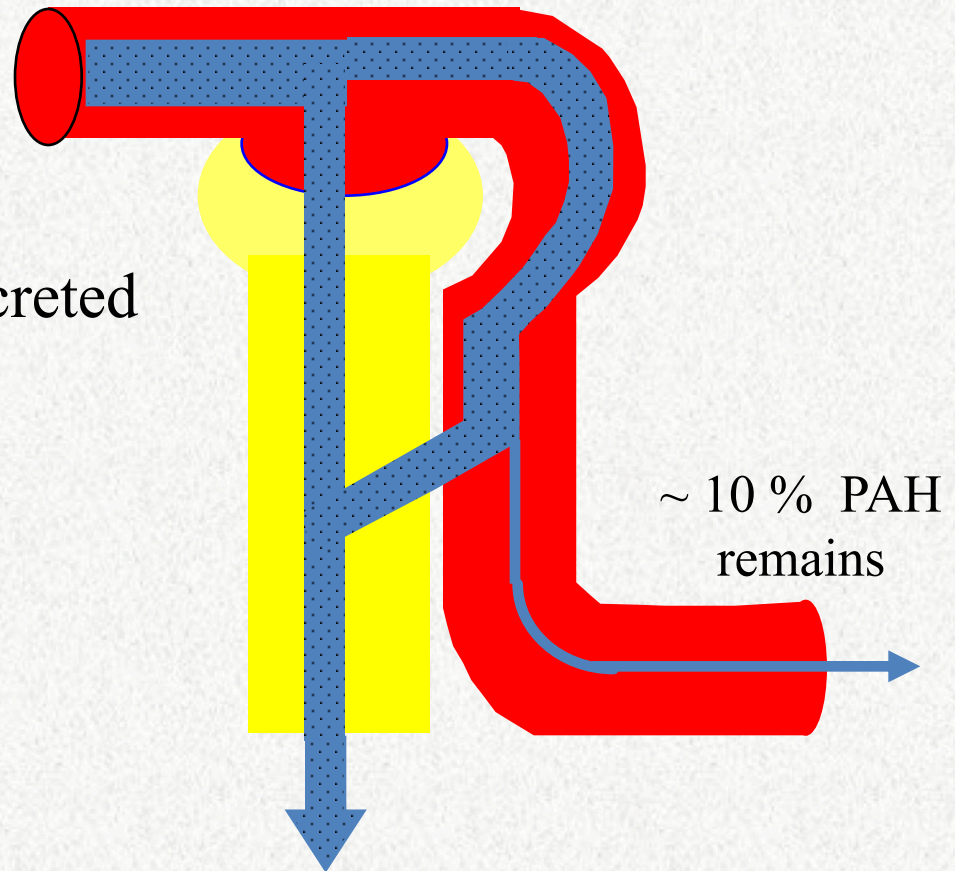

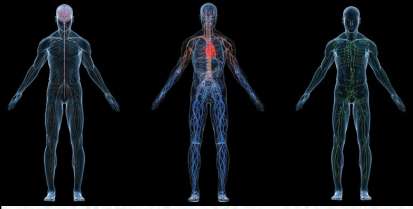

To calculate actual RPF , one must correct for incomplete extraction of PAH

$$A_{\text{PAH}} = 1.0$$

$$E_{\text{PAH}} = \frac{A_{\text{PAH}} - V_{\text{PAH}}}{A_{\text{PAH}}}$$
$$= \frac{1.0 - 0.1}{1.0} = 0.9$$

normally, $E_{\text{PAH}} = 0.9$

i.e PAH is 90 % extracted

$$\text{RPF} = \frac{\text{ERPF}}{E_{\text{PAH}}}$$

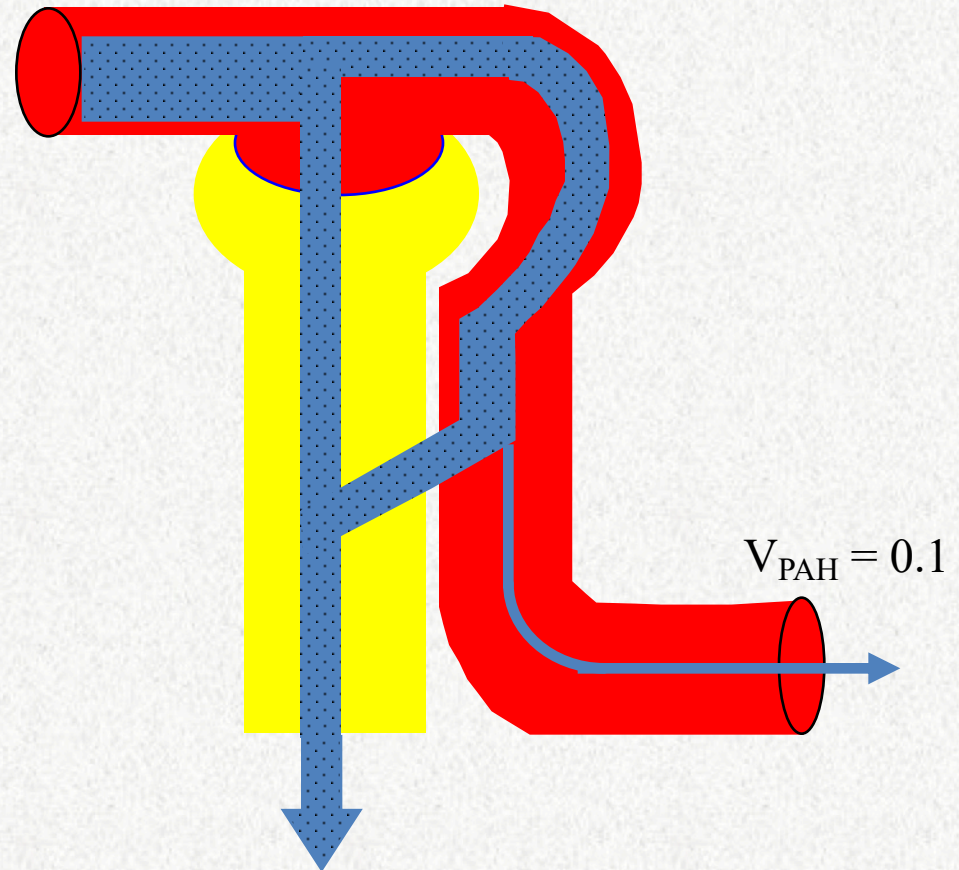

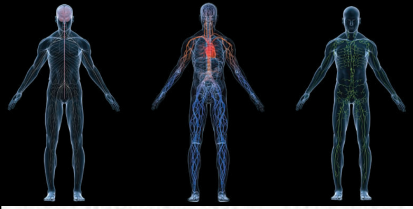

Calculation of Tubular Reabsorption

Reabsorption = Filtration - Excretion

$$\text{Filt } s = \text{GFR} \times P_s$$

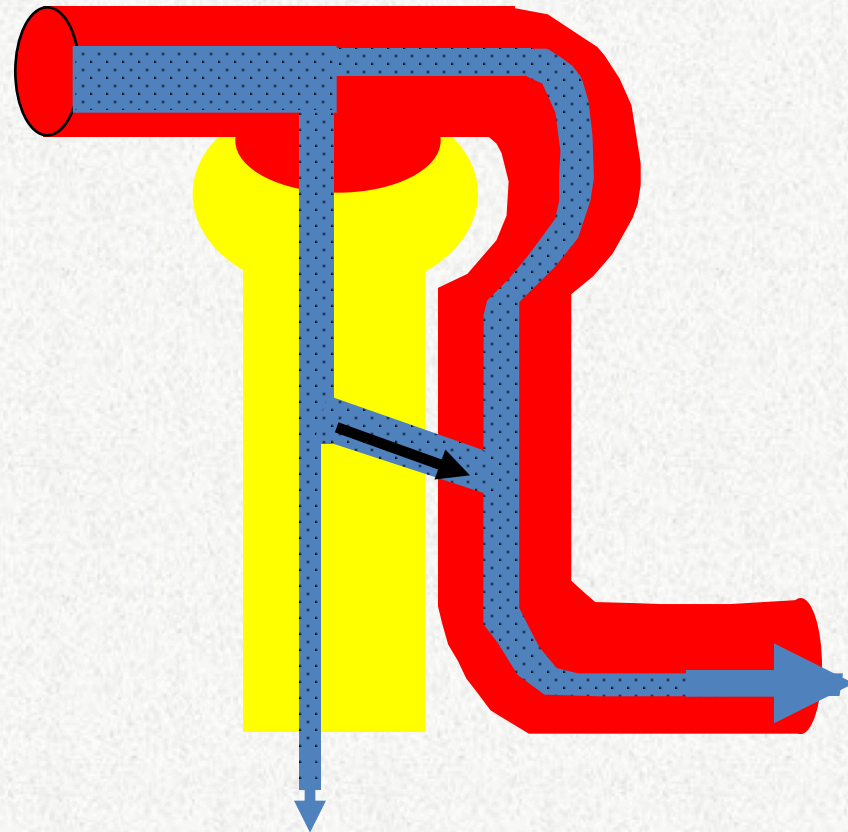

$$\text{Excret } s = U_s \times V$$

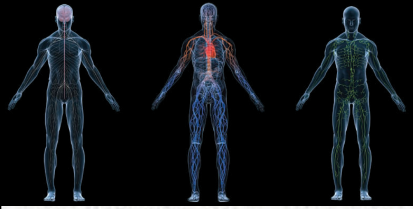

Calculation of Tubular Secretion

$$\text{Secretion} = \text{Excretion} - \text{Filtration}$$

$$\text{Filt } s = \text{GFR} \times P_s$$

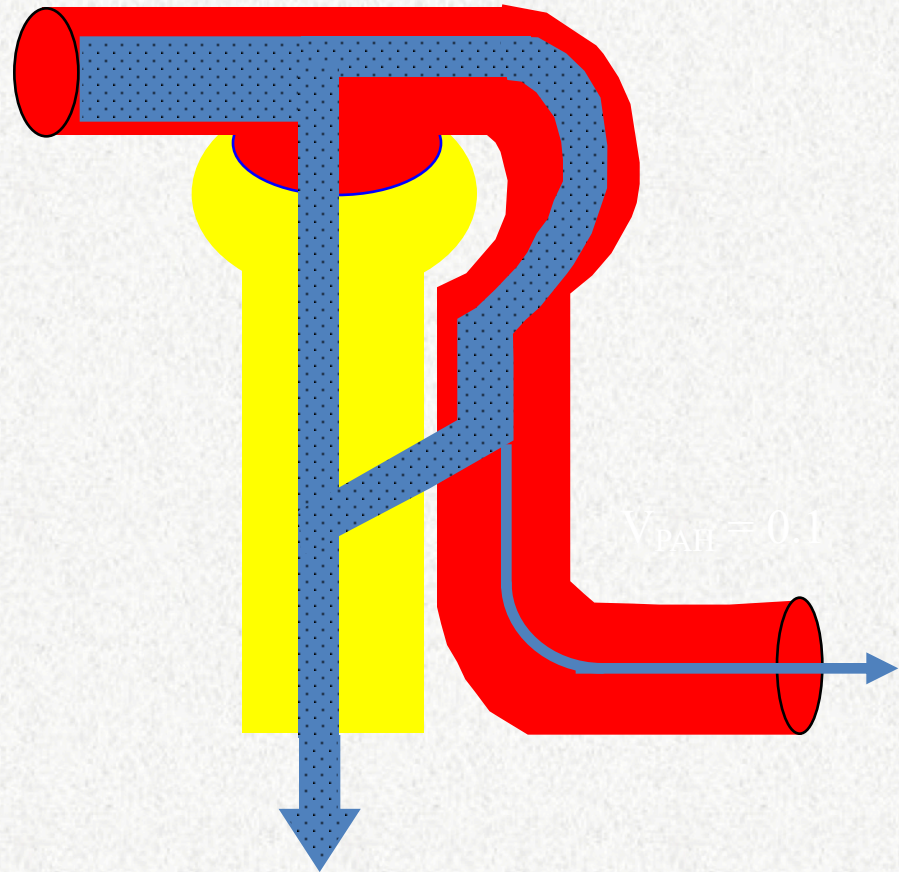

$$\text{Excret } s = U_s \times V$$

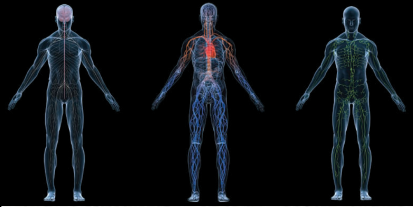

Question

The maximum possible clearance rate of a substance that is completely cleared from the plasma by the kidneys would be equal to

1. glomerular filtration rate
2. the filtered load of the substance
3. urine excretion rate of the substance
4. renal plasma flow
5. none of the above

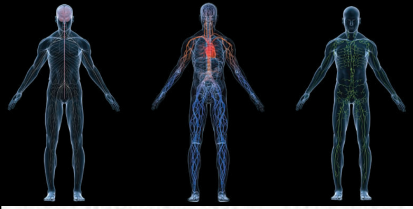

Use of Clearance to Estimate Renal Plasma Flow

Theoretically, if a substance is completely cleared from the plasma, its clearance rate would equal renal plasma flow

$$C_x = \text{renal plasma flow}$$

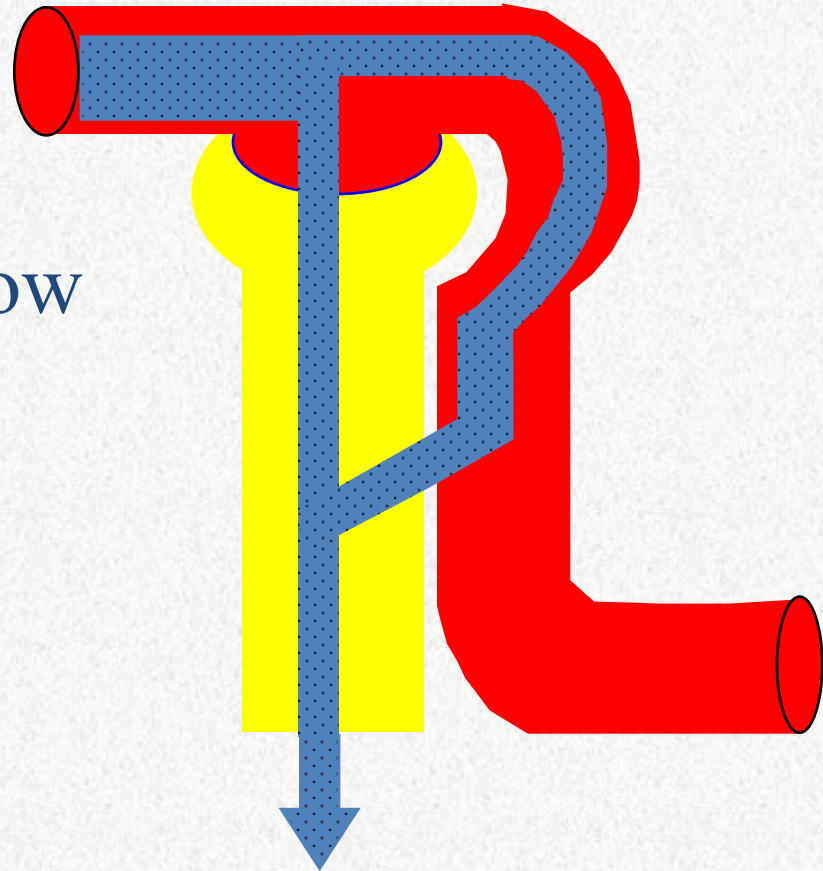

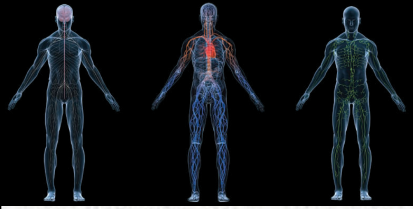

Clearances of Different Substances

Substance	Clearance (ml/min)
inulin	125
PAH	600
glucose	0
sodium	0.9
urea	70

Clearance of inulin (C_{in}) = GFR

if $C_x < C_{in}$: indicates reabsorption of x

if $C_x > C_{in}$: indicates secretion of x

Clearance creatinine (C_{creat}) ~ 140 (used to estimate GFR)

Clearance of PAH (C_{pah}) ~ effective renal plasma flow

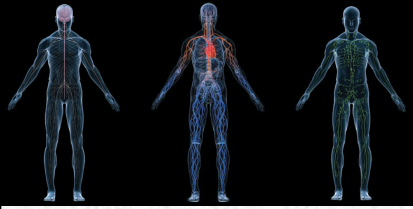

Effect of reducing GFR by 50 % on serum creatinine concentration and creatinine excretion rate

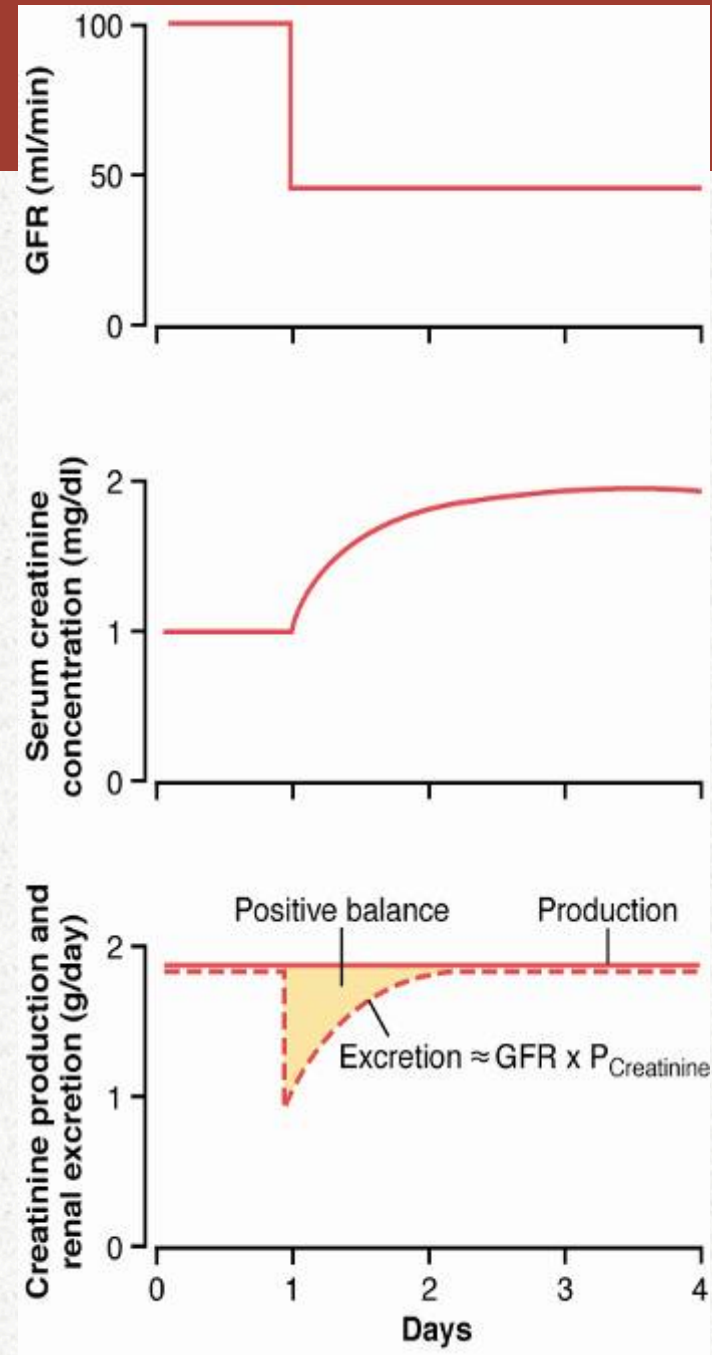
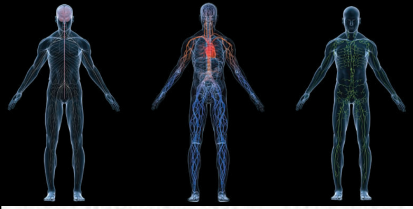

Figure 27-20



Plasma creatinine
can be used to
estimate changes
in GFR

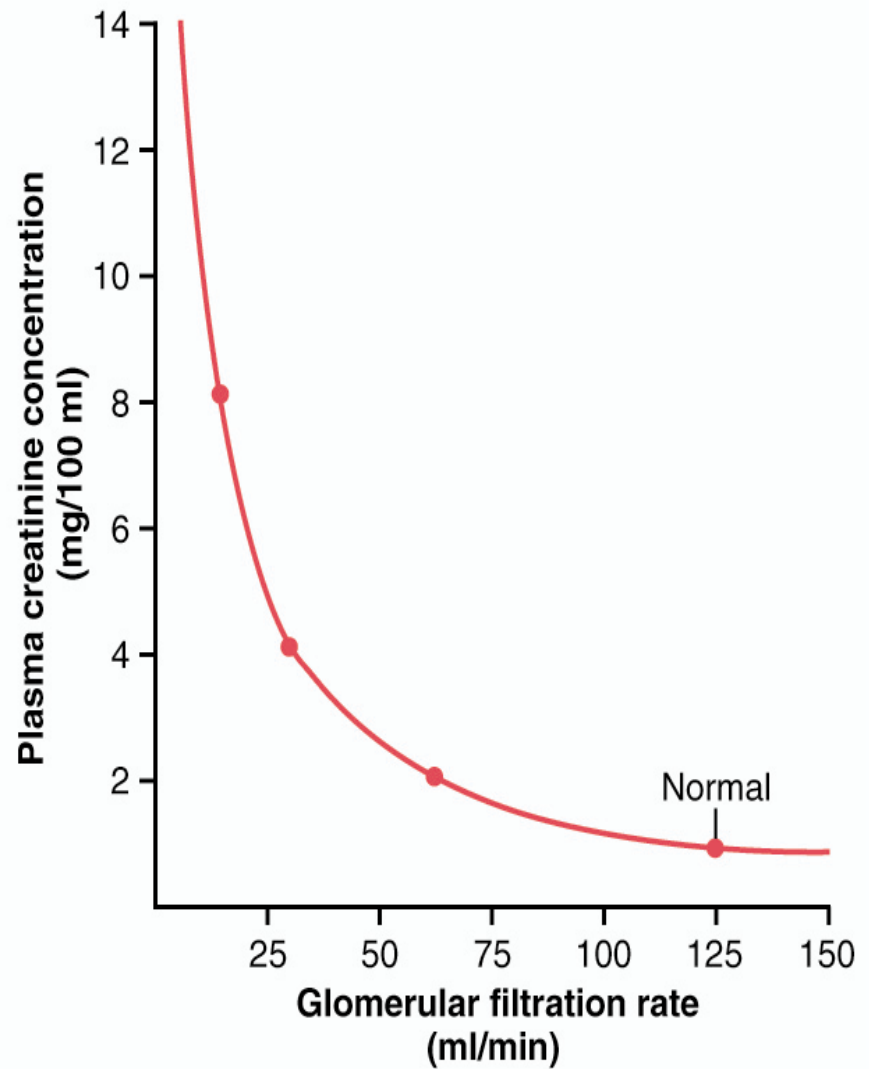

Figure 27-21